

Specifications

Standard Series

Model		BD-80CVE	BD-70CVE	BD-80CE	BD-70CE	
Washing Capacity (kg)		8.0	7.0	8.0	7.0	
Inverter Control		●	●	—	—	
Washing Functions	Washing Process	—	—	—	—	
	Intelligent Sensor Systems	Water Level Sensor	●	●	●	●
		Water Temperature Sensor	●	●	●	●
		3D Vibration Sensor	—	—	—	—
		Load Sensor	●	●	●	●
		Revolution Sensor	●	●	●	●
	Foam Detection Sensor	●	●	●	●	
	Vibration Control System	4-Ply Liquid Load Balancer	—	—	—	—
		Hydraulic Suspensions	—	—	—	—
	Self Correction System	●	●	●	●	
Spin Function	Max. Spin Speed (r/min)	1,200	1,200	1,200	1,200	
	Variable Spin Control	●	●	●	●	
	Tangle-Free Finish	●	●	●	●	
Useful Functions	Memory Timer	●	●	●	●	
	Option	Water Temperature	Cold / 20°C / 30°C / 40°C / 60°C / 90°C	Cold / 20°C / 30°C / 40°C / 60°C / 90°C	Cold / 20°C / 30°C / 40°C / 60°C / 90°C	Cold / 20°C / 30°C / 40°C / 60°C / 90°C
		Spin Speed (r/min)	0 / 400 / 600 / 800 / 1000 / 1200	0 / 400 / 600 / 800 / 1000 / 1200	0 / 400 / 600 / 800 / 1000 / 1200	0 / 400 / 600 / 800 / 1000 / 1200
	Intensive	—	—	—	—	
	Stain Level	High / Mid / Low	High / Mid / Low	High / Mid / Low	High / Mid / Low	
	Prewash	●	●	●	●	
	Extra Rinse	●	●	●	●	
	Rinse Hold	—	—	—	—	
	Clean Functions	Auto Self Clean (Allergy UK Approved)	—	—	—	—
		Tub Clean	● (90°C)	● (90°C)	● (90°C)	● (90°C)
Antibacterial Material		Gasket	Gasket	Gasket	Gasket	
Door Clean		●	●	●	●	
Washing Programs	No. of Program	15	15	15	15	
		Cotton / Mix Daily 45 / Daily 60 Rapid 15 Synthetic / Delicate Outdoor / Duvet Cotton Eco / Wool Baby Care / Memory Tub Clean Rinse & Spin Spin	Cotton / Mix Daily 45 / Daily 60 Rapid 15 Synthetic / Delicate Outdoor / Duvet Cotton Eco / Wool Baby Care / Memory Tub Clean Rinse & Spin Spin	Cotton / Mix Daily 45 / Daily 60 Rapid 15 Synthetic / Delicate Outdoor / Duvet Cotton Eco / Wool Baby Care / Memory Tub Clean Rinse & Spin Spin	Cotton / Mix Daily 45 / Daily 60 Rapid 15 Synthetic / Delicate Outdoor / Duvet Cotton Eco / Wool Baby Care / Memory Tub Clean Rinse & Spin Spin	
Structure	Heat Protective Cover	—	—	—	—	
	Control Panel	LED / Knob	LED / Knob	LED / Knob	LED / Knob	
	Detergent Drawer	All-in-One	All-in-One	All-in-One	All-in-One	
	Softener Drawer	—	—	—	—	
Reload	●	●	●	●		
Standby Power Zero W	—	—	—	—		
Auto Restart	●	●	●	●		
Auto Power Off	●	●	●	●		
Child Lock	●	●	●	●		
Safety lock	●	●	●	●		
Energy Consumption (kWh / Cycle)*1		0.64	0.56	0.82	0.74	
Water Consumption (L / Cycle)*1		43	34	45	38	
Dimensions (mm)*2	Width x Depth x Height	595 x 570 x 845	595 x 500 x 845	595 x 570 x 845	595 x 500 x 845	
	Without Worktop	—	—	—	—	
Minimum Installation Dimensions (Width x Depth x Height, mm)		635 x 585 x 870	635 x 515 x 870	635 x 585 x 870	635 x 515 x 870	
Body Colour		White		White		
Weight (Net / Gross, kg)		68 / 72	61 / 65	68 / 72	61 / 65	

*1 Based on COMMISSION DELEGATED REGULATION (EU) No 1061 / 2010
*2 Including drain hose and water supply hose

Dimensions (mm)

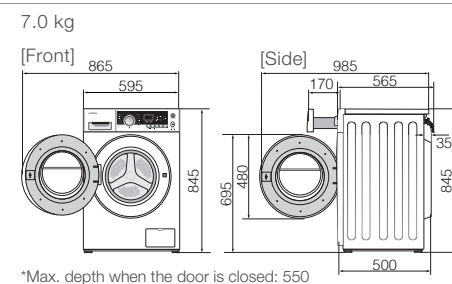
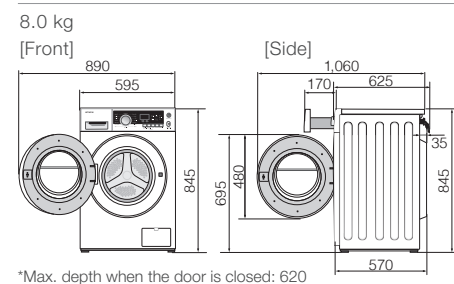

Washing Machine

Front Loading

HITACHI



BD-D120XGV

Arçelik Hitachi Home Appliances Sales (Singapore) Pte. Ltd.

T: +65 65362520 F: +65 65362521 Website: hitachi-homeappliances.com/sg

Printed Date: 25th February 2022.
All models & specifications in content are subjected to change without prior notice. Colour tone of actual products may differ from those shown in this catalogue.



Wind Iron

Smooth Out Wrinkles with a High-Speed Airflow of Approx. 270km/h*¹

The high-speed airflow of approx. 270 km/h*¹ generated by the Jet Fan Drying System is applied to the clothes and by spreading it out within the large drum capacity of approx. 80 litres, dries the clothes while smoothing out wrinkles.



* The image is for illustrative purposes only.

Wind Iron Technology

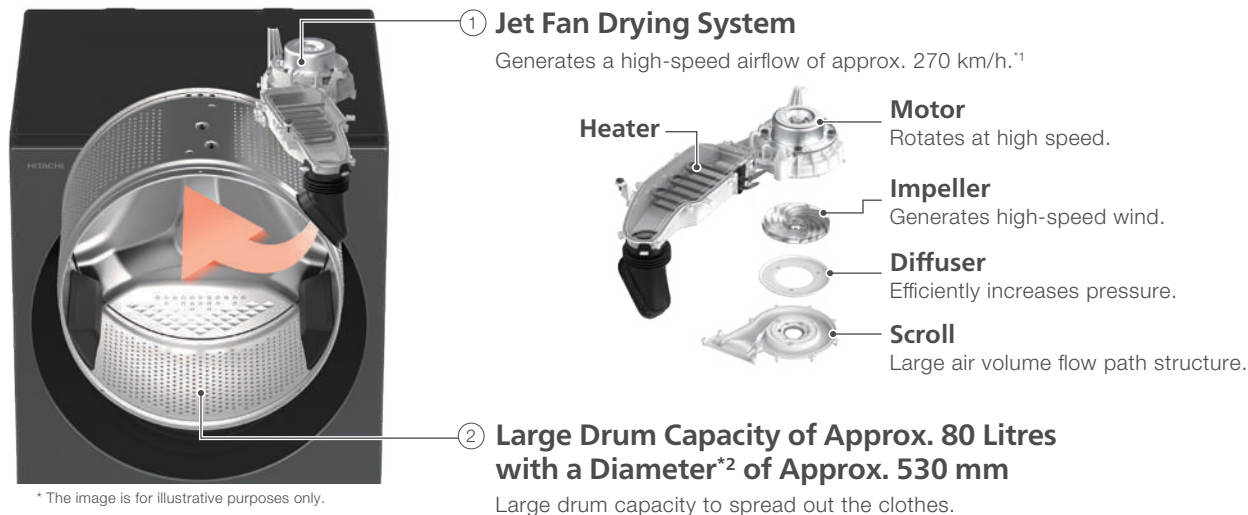

* The image is for illustrative purposes only.

*¹ Tested by Hitachi. The speed near the air outlet calculated from the area of the air outlet and wind volume.
*² Diameter of the inside of the drum.

Wrinkleless Clothes

Effortless laundry by reducing the work of ironing. The high-speed airflow smooths out wrinkles, and you can wear clothes directly out of the washing machine.



Without Wind Iron | With Wind Iron
Shirt / Cotton 100% *³

Drying-finish

	Drying Capacity	Shirt without Anti-Wrinkle Processing Polyester 65% Cotton 35%	Shirt without Anti-Wrinkle Processing Cotton 100%	Handkerchief Cotton 100%
Ready to wear without ironing.	1kg	* ⁴	* ⁴	* ⁴
This good, without ironing.	3kg	* ⁴	* ⁴	* ⁴
Few wrinkles even in heavy loads.	5kg	* ⁴	* ⁴	* ⁴

Fluffier Touch than Sun-Dried

Make a difference in the fluffiness of your towels.



Sun-Dried after Wash | With Wind iron *⁵
Towels / Cotton 100%

*³ Tested by Hitachi. Tested model and program: Comparison between the model BD-D80CVE without Wind Iron / Cotton / Dry Only 3 kg and BD-D120XGV with Wind Iron / AI Wash / Wash & Dry 3 kg. The performance may differ depending on the amount of clothes and materials and items being dried together.
*⁴ Tested by Hitachi. Tested Model: BD-D120XGV. Tested Program: AI Wash / Wash & Dry. The performance may differ depending on the amount of clothes and materials and the combination of laundry being dried.
*⁵ Tested by Hitachi. Tested Model: BD-D120XGV. Tested Program: AI Wash / Wash 5 kg for Sun-Dried after Wash and AI Wash / Wash & Dry 5 kg for with Wind Iron. The performance may differ depending on the amount of clothes and materials and the combination of laundry being dried.

Wash & Dry 60*1

Save Time with Your Laundry

Washing and drying can be finished in just 60 minutes.



* The image is for illustrative purposes only.

Steam Iron*2

Wrinkle and Odour Removal*3 in Only 15 Minutes

Suitable for busy mornings and before going out. Steam Iron program quickly and gently reduces wrinkles in folded clothes. Two shirts take only 15 minutes. This program reduces wrinkles in folded clothes and removes odours by making a high-humidity environment inside the drum and by applying a high-speed airflow to the clothes.

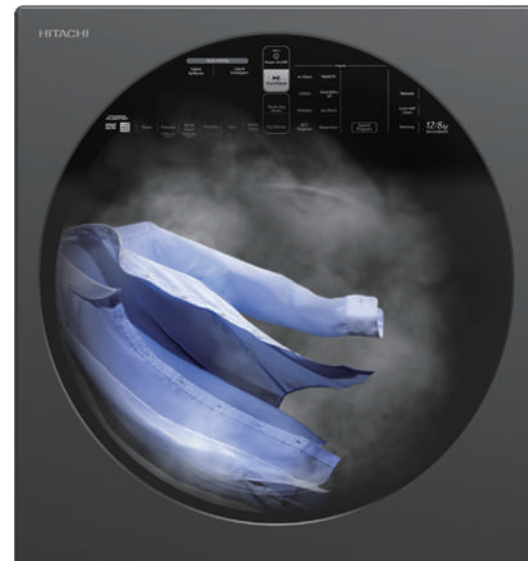

* The image is for illustrative purposes only.

Air Wash*4

Clean and Deodorise Items*5 That Cannot Be Washed Easily

For items that cannot be washed easily, now you can keep them clean without deteriorating to prevent deformation in items like suits, stuffed toys, and shoes. With Air Wash, heated and moisturised air reduces bacteria*6 and suppresses virus activities,*7 and also deodorises the items.



* The image is for illustrative purposes only.

*1 For loads under 1 kg of clothes such as 4 shirts. The performance may differ depending on the type and materials of clothes.

*2 For loads under 0.5 kg of dry clothes.

*3 The effect may differ depending on the materials of laundry items. Not all kinds of wrinkles and odours can be removed.

*4 For loads under 1 kg. Items such as leather and sponge materials cannot be washed.

*5 Not all kinds of odours, viruses and bacteria can be removed or suppressed.

*6 Air Wash [Maximum load: 1 kg; Required time (guide): 60 min] Test laboratory: Kitasato Research Center for Environmental Science / Document Number: 2021_0257 / Test method: Measurement of the rate of decrease of bacteria on plates attached to the test cloth. / Test result: Bacteria reduction rate of 99%.

*7 Air Wash [Maximum load: 1 kg; Required time (guide): 60 min] Test laboratory: Kitasato Research Center for Environmental Science / Document Number: 2021_0257 / Test method: Measurement of the rate of decrease of viruses on plates attached to the test cloth. / Test result: Virus reduction rate of 99%.

AI Wash

Optimal Washing with 8 Smart Sensing

Smart washing and clean result without troublesome settings required. The washing method and operating time are automatically determined according to various washing conditions such as the type of detergent, the textile of the laundry items, etc.

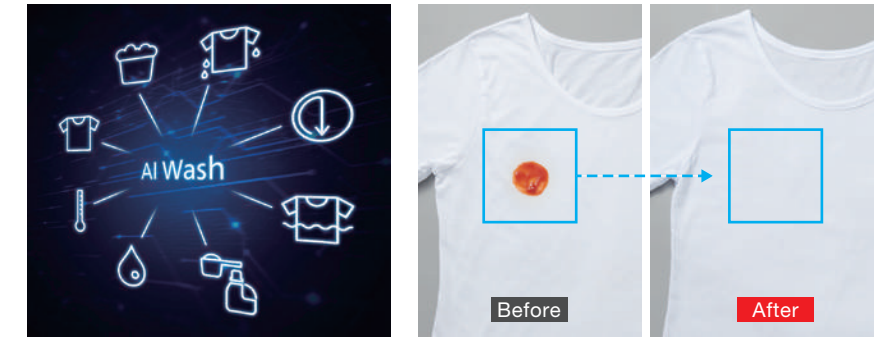

* The image is for illustrative purposes only.

Stain: Ketchup / Cotton 100% *8

Sensing for AI Wash to Make Your Laundry Smart

AI Wash automatically determines the washing method and time depending on various washing conditions. You can do your laundry smartly and cleanly without detailed settings required.

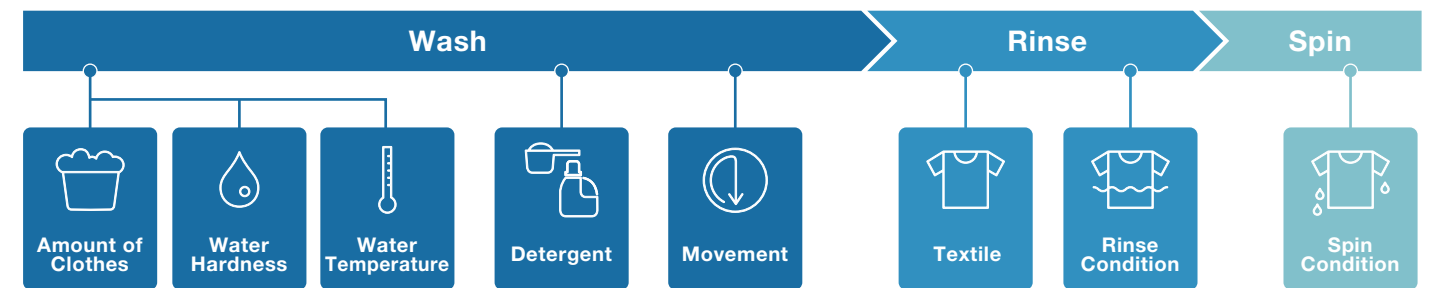

8 Sensing for AI Wash

- Amount of Clothes**
Set to the appropriate water level according to the amount of clothes.
- Water Hardness / Water Temperature**
Adjust the amount of detergent*9 and washing time according to the hardness and temperature of the water.
- Detergent*10**
Change washing control suitable for liquid detergent or powder detergent.
- Movement**
Adjust tub rotation speed to maximise the cleaning effect.
- Textile**
Reduce the amount of water by sensing synthetics.
- Rinse Condition**
Shorten rinsing time by sensing the rinsing condition.
- Spin Condition**
Shorten spinning time according to the remaining amount of water.

*8 Tested by Hitachi. Tested model: BD-120XGV. Tested program: AI Wash. When washing 7.2 kg (60% of washing loading capacity). The effect varies depending on the type and amount of dirt.

*9 Applies to only BD-D120XGV and BD-120XGV (When the Auto Dosing System function is ON).

*10 It may not be distinguishable depending on the type and amount of detergent.

Auto Dosing System*1

Great Washing Results with Less Effort

Proper amounts of liquid detergent and fabric softener are automatically dispensed according to the washing loading amount for a clean finish. Also, after dispensing liquid detergent, the route is washed with clean water.

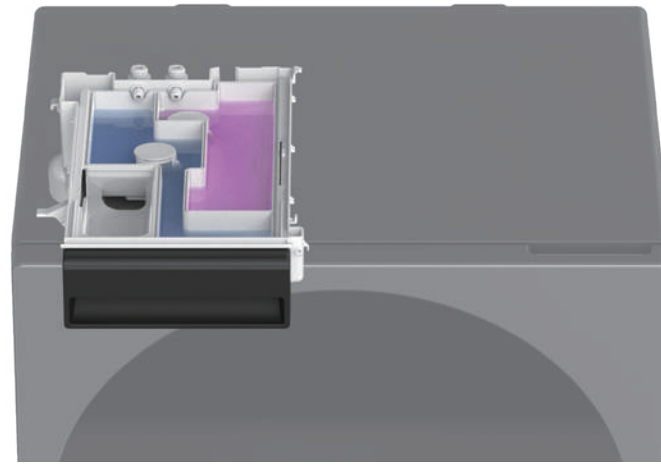

* The image is for illustrative purposes only.

Easily Refillable Large Capacity Tank

Washing 24 times*2 with a single filling of liquid detergent and fabric softener.

- ① Tank for Liquid Detergent: 1,000 mL
- ② Tank for Fabric Softener: 600 mL



Clean Tank

The tank is detachable for washing easily with clean water.



Easy Navigation

"Empty" shows the time for refilling at one glance. You can adjust the amount of liquid detergent and fabric softener according to your preference.



*1 Applies to BD-D120XGV and BD-120XGV.

*2 When the load is 5 kg and the standard amount setting is the same as the default setting. The number of times you can wash varies depending on the type of liquid detergent / fabric softener, the setting status, the remaining amount in the tank, etc. When the remaining amount in the tank is low ("Empty" on the control panel lights up), refill the liquid. The 24 times includes the number of washings after "Empty" lights up.

60°C Hygiene

Your Clean and Hygienic Clothes*3 with the Power of Hot Wash

The built-in heater heats the water to 60°C. Enjoy clean and hygienic clothes for you and your loved ones.

Bacteria Reduction*4

With 60°C hot water, bacteria are reduced to make your clothes hygienic.

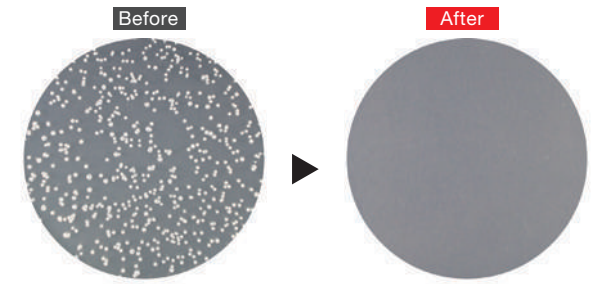

Removes Mites and Allergens*5 & Suppresses Virus Activities*6

Suitable for baby laundry. Removes mites and allergens, and also suppresses viruses in fibres with 60°C hot water.



*The image is for illustrative purposes only.

Auto Self Clean

Hygienic Washing Tub for Clothes You Care For

Allergy UK Approval Mould*7 & Bacteria*8 Reduction

Clean water at the bottom of the outer tub is pushed up to clean the entire tub.

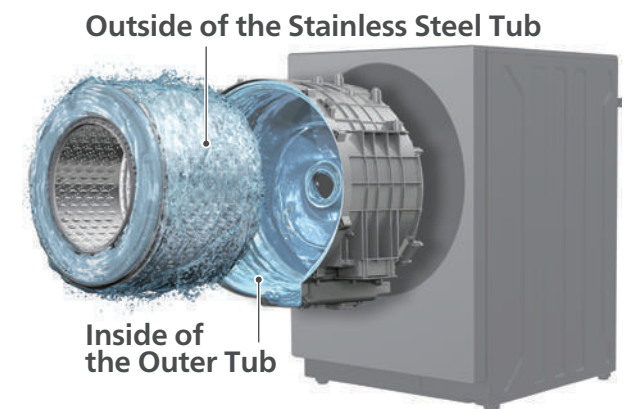

*The image is for illustrative purposes only.

These places easily get dirty*9



*3 Not all kinds of bacteria, viruses and mites and allergen can be removed.

*4 60°C Hygiene [Maximum load: 4 kg; Required time (guide): 157 min] Test laboratory: Kitasato Research Center for Environmental Science / Test Report Number: 2021_0208 / Test method: Measurement of the rate of decrease of bacteria on plates attached to the test cloth. / Test result: Bacteria reduction rate of 99.99%.

*5 60°C Hygiene [Maximum load: 4 kg; Required time (guide): 157 min] Test laboratory: FCG Research Institute, Inc. / Test method: Measurement (Hitachi standards) of dead dust mites stuck to sheets. / Test result: Dust mite death rate of 99%. / Test method: Measurement (Hitachi standards) of amount of dust mite allergens (droppings/bodies). / Test result: Dust mite allergen reduction rate of 97%.

*6 60°C Hygiene [Maximum load: 4 kg; Required time (guide): 157 min] Test laboratory: Kitasato Research Center for Environmental Science / Document Number: 2021_1208 / Test method: Measurement of the rate of decrease of viruses on plates attached to the test cloth. / Test result: Virus reduction rate of 99.99%.

*7 Test Laboratory: Kitasato Research Center for Environmental Science / Test Report Number: 2021_0192 / Test Method: Measurement of the rate of decrease of mould spores on culture plates attached to the inside of the outer tub and the outside of the stainless steel tub when using the Auto Self Clean function. / Test Object: The outside of the stainless steel tub and the inside of the outer tub. / Test Result: Mould reduction rate of 99%.

*8 Test Laboratory: Kitasato Research Center for Environmental Science / Test Report Number: 2021_1192 / Test Method: Measurement of the rate of decrease of bacteria on plates attached to the inside of the outer tub and the outside of the stainless steel tub when using the Auto Self Clean function. / Test Object: The outside of the stainless steel tub and the inside of the outer tub. / Test Result: Bacteria reduction rate of 99%.

*9 An old Hitachi model made in Japan without Auto Self Clean function. The level of dirt differs depending on the conditions of use.

Antibacterial*¹ & Mouldproof*² Shower Lifter and Gasket



Shower Lifter

Gasket

User-friendly Design

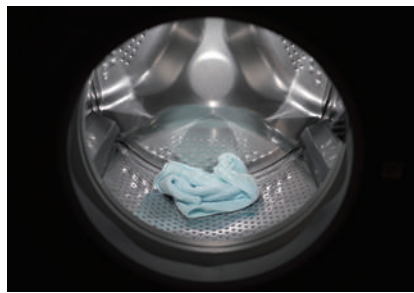

Interior Lighting*³



Panel Door with Wide Opening



Glass Touch Display

* The image is for illustrative purposes only.

Low Vibration, Low Noise Operation



* The image is for illustrative purposes only.

Dual Vibration Control System +

The technology has achieved low vibration and low noise operation to not disturb your loved ones even while achieving high-speed spinning of 1,600 RPM and large capacity with a 530 mm diameter washing tub.

A 5-Ply Liquid Load Balancer

Reduces vibration and vibrating width when the tub rotates.

B 4-Friction Damper

Suppresses vibration of the tub and impact transmitted to the floor.



* The image is for illustrative purposes only.

3D Acceleration Sensor

Detects complex vibrations in the front-back, left-right, and up-down directions and adjusts the tub rotating speed to suppress vibrations.

Hitachi Washer App*^{5*6}

IoT Connected*⁷

Supports washing in cooperation with a smartphone app.



Notification

Get push notifications for a completed washing operation, clothes remaining in the tub and Tub Wash timing.

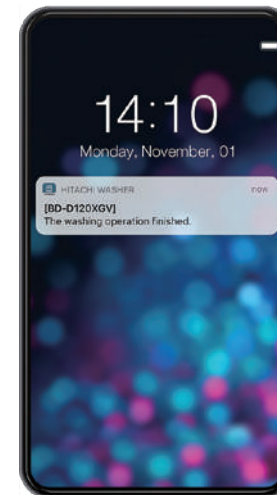

Download Program*⁸

Download the washing programs from Hitachi Washer App for your laundry.

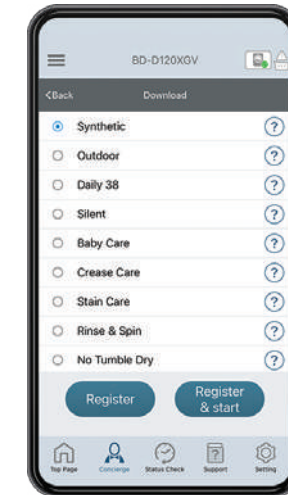

for Washer Dryer

Synthetic / Outdoor / Daily 38 / Silent / Baby Care / Crease Care / Stain Care / Rinse & Spin*⁹ / No Tumble Dry / Hot Tub Wash / Tub Dry

for Washer

Synthetic / Outdoor / Baby Care / Rinse & Spin*⁹ / Hot Tub Wash

Concierge (Laundry Assistant)

Recommends the washing programs by selecting the type of clothes for your laundry or life scene.

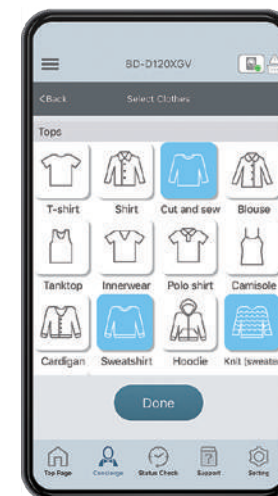

Remote Control*¹⁰

Start operation and check the operation status even when you are not near the washing machine. You can change the end time of the reserved operation before the operation starts.

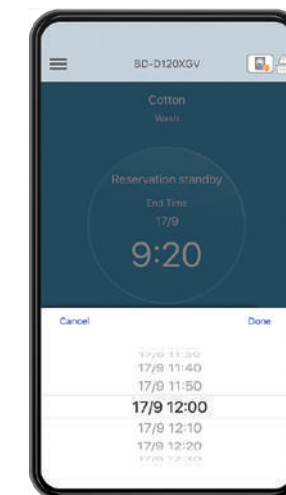

Support

Easy instruction manuals and maintenance access anytime, anywhere.

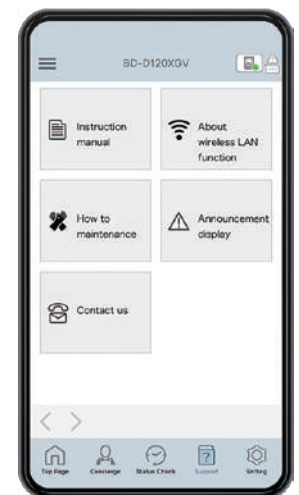

*⁵ Applies to BD-D120XGV and BD-120XGV.

*⁶ Not responsible for any damages, loss and default caused by downloading the application.

*⁷ Requires an internet connection and a wireless LAN router. Use a wireless LAN router that can set WPA2 or WPA (with TKIP or AES) as the encryption method. The communication standards need to correspond to any of IEEE 802.11b/g/n (2.4 GHz only). Email registration is required before using the application. The application is not charged, but communication costs are charged when downloading and using the application. Communication costs will be borne by the customer who has contracted for the smartphone that is used. Please use after agreeing to the terms of use and the privacy policy of the dedicated application. The contents of services, screen design, functions, etc. of the application may change without notice. Also, the service provided may be terminated without notice.

*⁸ With registration of the washing programs in the washing machine, you can operate without the application. You can save one favourite program and change it depending on your needs.

*⁹ Rinse & Spin program is default-set in the products on shipment.

*¹⁰ When operating the unit from your smartphone, please set to the remote-control standby mode by pressing "Remote" button on the unit.

*¹ Test Laboratory: BOKEN / Test Report Number: 213251774-1, 213237371-1 / Test Method: JIS Z 2801 / Test Object: Shower Lifter and Door Gasket. / Test Result: Antibacterial activity value of 2.0 or more.

*² Test Laboratory: BOKEN / Test Report Number: 213251774-2, 213237371-2 / Test Method: JIS Z 2911 / Test Object: Shower Lifter and Door Gasket. / Test Result: Mould resistance display 0.

*³ Applies to only BD-D120XGV and BD-120XGV.

*⁴ Diameter of the inside of the drum.

Washer Dryer



BD-D120XGV
Wash 12 kg / Dry 8 kg
Mauve Gray

WIND IRON POWERED INVERTER



Features

- Wind Iron
- AI Wash
- Auto Dosing System
- Auto Self Clean
- Interior Lightning
- Hitachi Washer App
- Inverter



BD-D120GV
Wash 12 kg / Dry 8 kg



BD-D100GV
Wash 10 kg / Dry 7 kg
White

WIND IRON POWERED INVERTER



Features

- Wind Iron
- AI Wash
- Auto Self Clean
- Inverter

Washer



BD-120XGV
Wash 12 kg
Mauve Gray

POWERED INVERTER



Features

- AI Wash
- Auto Dosing System
- Auto Self Clean
- Interior Lightning
- Hitachi Washer App
- Inverter



BD-120GV
Wash 12 kg



BD-100GV
Wash 10 kg

White

POWERED INVERTER



Features

- AI Wash
- Auto Self Clean
- Inverter



Powered Inverter

Quick Washing

45 min / 15 min

Programs Available *60min for the BD-W90AV.

**POWERED
INVERTER**



BD-90XFV
Metallic Silver



BD-90YAV
White



BD-W90AV
White

DVCS Dual Vibration Control System

Less Noise Operating System from Start to Finish

4-Ply Liquid Load Balancer



If the items in the drum become unevenly balanced, liquid inside the 4-ply chamber moves to the opposite side of the load to offset the imbalance. Making the drum better balanced dramatically reduces vibrations.

High-Damping Hydraulic Suspension



Two oil pressure suspensions, just like the system used in automobiles, support the drum and flexibly change the degree of damping to match the amplitude of vibrations to dramatically reduce them. The support for two suspensions also minimises the transmission of vibration to the washing machine casing.



*The image is for illustrative purposes only.

3D Vibration Sensor* and Revolution Sensor

The 3D Vibration Sensor detects drum vibrations in three dimensions. At the same time, the Revolution Sensor constantly monitors drum rotation speed and controls it based on information provided by the 3D Vibration Sensor.

*Applies to the BD-90XFV and 90YAV.

Anti-Vibration Sidewalls

Even the sidewalls are designed to reduce noise and vibrations.

Strength analysis of the casing enables a design ensuring minimal displacement.

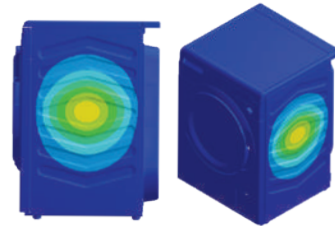

*The image is for illustrative purposes only.

Intelligent Sensor Systems

The Intelligent Sensor Systems detect load size and fabric type to determine both appropriate washing time and amount of water to use. The result is an outstanding washing performance with no wasted energy or water.



3D Vibration Sensor

Detects drum motion in three dimensions, determines the type of fabric, and working with the Revolution Sensor, controls drum rotation speed to minimise vibrations at all times.

*Applies to the BD-90XFV and 90YAV.



Load Sensor

Detects the size of the load and determines the amount of water, the wash time, drum rotation speed, and even when to switch the heater on for optimal energy-saving operation.



Water Level Sensor

Sets the optimal water level to match the load while constantly monitoring conditions to prevent water wastage.



Revolution Sensor

Constantly monitors drum rotation speed during washing and spin-drying, working with the 3D Vibration Sensor to maintain optimal rotation speed.



Water Temperature Sensor

Constantly monitors water temperature to maintain the set temperature and prevent energy-wasting overheating.



Foam Detection Sensor

Detects excessive foam generated and eliminates it to maintain normal operation.



Various Washing Programs



Cotton

For daily washing of cotton and linen items such as shirts, underwear, towels, bed linen and table linen.



Mix

Lightly soiled items can be washed together with different types of laundry.



Allergy Care

Removes allergens such as house dust mites, mold and bacteria. Tested and approved by Allergy UK.



Cotton Eco

For cotton and linen items. Saves energy and water with a prolonged wash.



Delicate

Gentle wash program for delicate items such as lingerie and thin lace curtains.



Crease Care

Gentle spin and increased water for easily wrinkled fabrics.



Rapid 15

For washing small loads of lightly soiled and or small items in 15 minutes. It's also ideal for freshening up just-worn clothes.



Outdoor

For washing heavily soiled durable clothes such as jeans, sportswear, etc.



Rinse & Spin

For rinsing and spin-drying only, recommended for hand washed items.



Daily 45

For washing lightly soiled items in just 45 minutes. *Not applicable to the BD-W90AV.



Duvet

For washable large items such as duvets, blankets, bedspreads, etc.



Spin

Use to spin-dry hand washed items, or after using Rinse Hold.



Daily 60

For washing lightly soiled items in just 60 minutes. *Applies to the BD-W90AV only.



Drain

For emptying out water remaining after the last rinse when using a program with the Rinse Hold option.



Tub Clean

For cleaning the inside of the washing machine. Using this cycle regularly keeps the tub clean and prevents the growth of mould.



Synthetic

For washing normally soiled blouses, shirts, etc. made of polyester, acrylic or blends with cotton.

Options for Various Fine Settings

Memory

Allows you to store a customised wash cycle which you use frequently.

Extra Rinse

Recommended for areas with very hard water, when washing baby linen, and for people allergic to detergent, this option lets you give washing an extra rinse.

Temp

Enables temperature setting from cold up to 90°C. When you select cold, the heater switches off.

Rinse Hold

Laundry remains in the last rinse water without progressing to the final spin cycle to prevent the clothes from wrinkling.

Intensive

Provides extended washing time for more thorough washing of heavily soiled items.

Prewash

Prewashes heavily soiled items before the main wash.

Timer

Lets you program a wash to finish up to 24 hours later.

Spin

Enables spin speed setting from 0 to Max r/min. By selecting '0' (No Spin) the water is drained out only, which is recommended for delicate fabrics.

User-Friendly Functions

LED Multi Functional Display

Easy pictographic option menu and program indicators.

Self Correction System

During operation, if a lot of foam develops or the tub becomes unbalanced preventing the regular spin-drying, operation is automatically corrected.



180° Open Door and Large 330 mm Diameter Opening

Enables easy loading and unloading of items for extra convenience.



Tangle-Free Finish

When the spin cycle ends, the drum repeatedly moves clockwise and counter clockwise, first making items fall off the drum wall and then untangling them. This unique Hitachi feature makes it much easier to remove clothes from the drum.

*Tangle-Free Finish will not be activated with certain load capacities or settings.



*The image is for illustrative purposes only.

Easy Reloading

When you want to add more items halfway through the wash cycle, all you do is to press the "Start / Pause" button and add them to the drum, press it again to resume the washing. This is convenient when you find some items left after the cycle started.



Auto Power Off

To avoid wasting energy, power is automatically switched off after operation.



Fully Auto Restart

In the event of a power cutoff, the phase of the laundry cycle (wash / rinse / spin) is remembered. When power is restored, it automatically restarts from the beginning of the last phase.

*Semi Auto Restart for the BD-W85AAE and W75AAE.

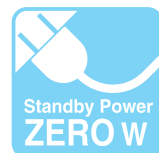

Standby Power Zero W

When not operating, Hitachi front loading washers use no electricity.



Child Lock

Disables the operation buttons and dial, and also locks the door.



Water Leak Detection (Optional)

Stops the supply of water automatically. The user is alerted when there's a leak.

Under-Counter Installation



Top plate* (Optional)

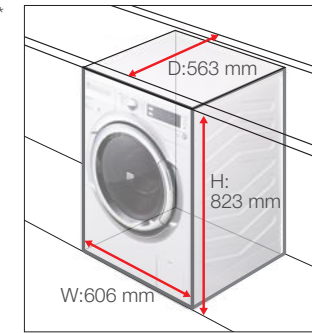

Heat Protective Cover

Minimum Installation Dimensions

If you intend to install the unit under a counter, a minimum clearance of 3 mm for the top and back as well as 6 mm on both sides is required. If there is too much space between the top of the unit and the counter, you can use the four adjustable leveling feet to make the unit up to 12 mm taller for a precise fit under counters of various heights.

*Image is for W75AAE only.

*The image is for illustrative purposes only.

Heat Protective Cover

You will never burn yourself from accidentally touching when in operation.

*Applies to the BD-90XFV only.

Removable Worktop

The worktop of 30 mm is detachable for neat installation under a counter. The 560 mm deep, 8.0 / 7.5 kg models are just right for the standard counter size.

*If the height of the under counter space is between 823 mm and 852 mm, please remove the worktop and place a top plate (optional) for a proper installation.

Safety Measures That Go One Step Beyond

Adhering to the strict manufacturing and engineering practices, Hitachi is doing everything possible to protect your valued property.

Safety measures for the motor



Safety measures for the heater



Safety measures for the printed circuit boards



*The image is for illustrative purposes only.

Washer



BD-90XFV 9.0 kg

POWERED INVERTER
1,600 rpm



Metallic Silver



Features

- Powered Inverter
- Auto Self Clean
- Big Drum 510
- Dual Vibration Control System
- Intelligent Sensor Systems
- 3D Sensor Control Wash
- LED Multi Functional Display
- 180° Open Door
- Self Correction System
- Tangle-Free Finish
- Reload
- Heat Protective Cover
- Auto Power Off
- Standby Power Zero W
- Fully Auto Restart
- 16 Programs
- Special Programs
 - Mix / Daily 45 / Duvet / Allergy Care / Crease Care
- Optional Menus
 - Memory / Timer / Intensive / Prewash / Extra Rinse / Rinse Hold

Control Panel

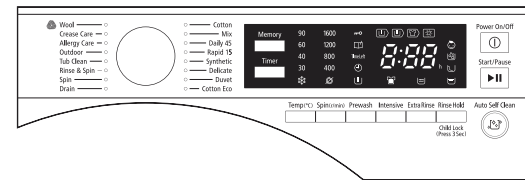

BD-90YAV 9.0 kg

POWERED INVERTER
1,200 rpm



White



Features

- Powered Inverter
- Auto Self Clean
- Big Drum 510
- Dual Vibration Control System
- Intelligent Sensor Systems
- 3D Sensor Control Wash
- LED Multi Functional Display
- 180° Open Door
- Self Correction System
- Tangle-Free Finish
- Reload
- Auto Power Off
- Standby Power Zero W
- Fully Auto Restart
- 16 Programs
- Special Programs
 - Mix / Daily 45 / Duvet / Allergy Care / Crease Care
- Optional Menus
 - Memory / Timer / Intensive / Prewash / Extra Rinse / Rinse Hold

Control Panel

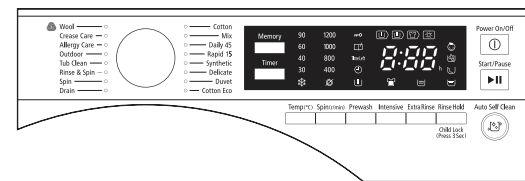

BD-W90AV 9.0 kg

POWERED INVERTER
1,000 rpm



White



Features

- Powered Inverter
- Auto Self Clean
- Big Drum 510
- Dual Vibration Control System
- Intelligent Sensor Systems
- LED Multi Functional Display
- 180° Open Door
- Self Correction System
- Tangle-Free Finish
- Reload
- Auto Power Off
- Standby Power Zero W
- Fully Auto Restart
- 16 Programs
- Special Programs
 - Mix / Daily 60 / Duvet / Allergy Care / Crease Care
- Optional Menus
 - Memory / Timer / Intensive / Prewash / Extra Rinse / Rinse Hold

Control Panel

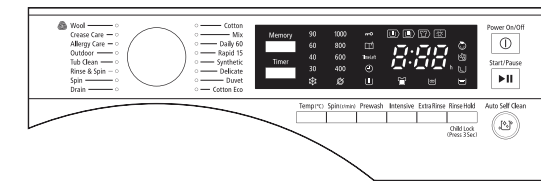

BD-W85AAE 8.5 kg
BD-W75AAE 7.5 kg

1,200 rpm



White 8.5kg



White 7.5kg



Features

- Auto Self Clean
- Big Drum 510
- Dual Vibration Control System
- Intelligent Sensor Systems
- LED Multi Functional Display
- 180° Open Door
- Self Correction System
- Tangle-Free Finish
- Reload
- Auto Power Off
- Standby Power Zero W
- Semi Auto Restart
- 16 Programs
- Special Programs
 - Mix / Daily 45 / Duvet / Allergy Care / Crease Care
- Optional Menus
 - Memory / Timer / Intensive / Prewash / Extra Rinse / Rinse Hold

Control Panel

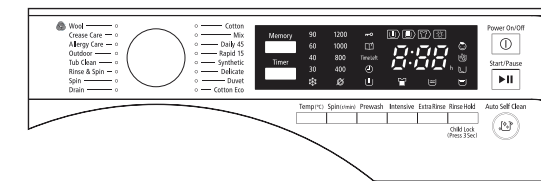

Designed for Your Peace of Mind



Allergy UK

The Auto Self Clean function has been awarded the Seal of Approval by Allergy UK. By reducing mould and bacteria.

Ready to Remove Any Dirt Thoroughly

Selectable Stain Level

You can select from the three options of High / Medium (Mid.) / Low, depending on the level of stains on your laundry. Each has different wash time to remove dirt and stains efficiently.

- High** For heavily soiled items or greasy stains, wash them away thoroughly.
- Medium** For daily washing.
- Low** For lightly soiled items, giving them a quick wash. Shorter wash time means less damage to fabrics.



Lifter and Drum Design for High Washing Efficiency

The uniquely shaped lifter and the drum patterns provide a wash board effect for a highly efficient washing.

Ways to Keep Your Washing Machine Clean

Door Clean

During the spin cycle, foam or detergent residue that is left on the glass door and gasket can be thoroughly washed away with clean water. No need to clean them yourself.



*The image is for illustrative purposes only.

90°C Tub Cleaning

Select the Tub Clean program and it cleans the inside tubs with 90°C hot water. The high temperature strong water flow washes the gap between inner and outer drums, keeping them clean and hygienic.



Antibacterial Gasket

The gasket features antibacterial materials.

* Test laboratory: Jiangsu JCT Testing Technology Services CO., LTD. / Test report number: JCT191209-007 / Test method: After culturing according to GB21551.2-2010, the number of viable bacteria are measured, and the antibacterial rate of the sample is compared and calculated. / Test object: Door Gasket / Test result: Mildew proof level 0, Antibacterial rate is 99.99% and more.

For Your Convenience

Time Saver Programs

Equipped with three quick wash programs.

- 15 Rapid 15** Extra short 15-minute program suitable for lightly soiled items or small loads.
- 45 Daily 45** For washing lightly soiled items or small loads in a short 45 minutes.
- 60 Daily 60** For washing lightly soiled items or small loads quickly in 60 minutes.



Tangle-Free Finish

When the spin cycle ends, the drum repeatedly moves clockwise and counter clockwise, first making items fall off the drum wall and then untangling them. This feature makes it much easier to remove clothes from the drum. Minimal Tangling means fewer wrinkles on clothes left in the drum for a long time after spin-drying.



*Tangle-Free Finish will not be activated with certain load capacities or settings.

*The image is for illustrative purposes only.

Reload Function

When you want to add more items halfway through the wash cycle, all you do is to press the "Start / Pause" button for three seconds and add them to the drum, press it again to resume the washing. This is convenient when you find some items left after the cycle started.



BD-80CVE 8.0 kg
BD-70CVE 7.0 kg

INVERTER
1,200 rpm

White

Features

- Inverter
- Selectable Stain Level
- Door Clean
- LED Multi Functional Display
- Tangle-Free Finish
- Reload
- Auto Power Off
- Fully Auto Restart
- 15 Programs Special Programs 90°C Tub Clean / Baby Care / Rapid 15 / Daily 45 / Daily 60
- Optional Menus Timer / Stain Level Prewash / Extra Rinse



BD-80CE 8.0 kg
BD-70CE 7.0 kg

1,200 rpm

White

Features

- Selectable Stain Level
- Door Clean
- LED Multi Functional Display
- Tangle-Free Finish
- Reload
- Auto Power Off
- Fully Auto Restart
- 15 Programs Special Programs 90°C Tub Clean / Baby Care / Rapid 15 / Daily 45 / Daily 60
- Optional Menus Timer / Stain Level Prewash / Extra Rinse

Specifications

Model	Washer Dryer			Washer				
	BD-D120XGV	BD-D120GV	BD-D100GV	BD-120XGV	BD-120GV	BD-100GV		
Capacity	Washing Capacity (kg)	12	12	10	12	12		
	Drying Capacity (kg)	8	8	7	-	-		
General	Colour	Mauve Gray	White	Mauve Gray	White	White		
	Interface	Glass Touch Switch			Glass Touch Switch			
	Drum Type	Big Drum 530 mm Diameter			Big Drum 530 mm Diameter			
	Gasket	Antibacterial ¹ & Mouldproof ²			Antibacterial ¹ & Mouldproof ²			
	Shower Lifter	Antibacterial ¹ & Mouldproof ²			Antibacterial ¹ & Mouldproof ²			
	Wide Opening Door	●			●			
	Inverter	●			●			
	Dual Vibration Control System +	●			●			
	LabelNo.5	WELS 4-ticks			WELS 4-ticks			
	Performance Feature	Reload	●			●		
Prewash		●			●			
Intensive		-			●			
Rinse Hold		●			●			
Rinse Count		●			●			
Max Spin Speed (RPM)		1,600			1,600			
Water Temperature		Cold / 30°C / 40°C / 60°C / 90°C			Cold / 30°C / 40°C / 60°C / 90°C			
Child Lock		●			●			
Timer		●			●			
Auto Self Clean		●			●			
Interior Lighting		●	-	-	●	-	-	
Memory (Program+Setting)		●			●			
Drying Feature		Wind Iron	●			-		
		Time Dry	●			-		
		Dry Option	Low Temp. / Extra Dry			-		
		Liquid Detergent	●	-	-	●	-	-
Auto Dosing System		Fabric Softener	●	-	-	●	-	
		Low Level Notification	●	-	-	●	-	
		Adjust Function	More / Less	-	-	More / Less	-	
		Smartphone App	Hitachi Washer App	●	-	-	●	-
Program (●)	AI Wash	●	●	●	●	●		
	Cotton	●	●	●	●	●		
Download Program ³ (○)	Synthetic	○	-	-	○	-		
	Delicate	●	●	●	●	●		
	Wool	●	●	●	●	●		
	Duvet	●	●	●	●	●		
	Outdoor	○	-	-	○	-		
	Rapid 15	●	●	●	●	●		
	Daily 38	○	-	-	○	-		
	Silent	○	-	-	○	-		
	Baby Care	○	-	-	○	-		
	Crease Care	○	-	-	○	-		
	Stain Care	○	-	-	○	-		
	60°C Hygiene	●	●	●	●	●		
	Air Wash	●	●	-	●	-		
	Steam Iron	●	●	-	●	-		
	Spin	●	●	●	●	●		
	Rinse & Spin	○	-	-	○	-		
	Wash & Dry 60	●	●	-	●	-		
	Dry Only	●	●	-	●	-		
	No Tumble Dry	○	-	-	○	-		
	Tub Wash	●	●	●	●	●		
Hot Tub Wash	○	-	-	○	-			
Tub Dry	○	-	-	○	-			
Download (default: Rinse & Spin)	●	-	-	●	-			
Dimensions (mm)	Width x Depth x Height	600 x 650 x 850			600 x 650 x 850			
Weight (Net / Gross, kg)		72 / 77			68 / 73			

¹ Test Laboratory: BOKEN / Test Report Number: 213251774-1, 213237371-1 / Test Method: JIS Z 2801 / Test Object: Shower Lifter and Door Gasket / Test Result: Antibacterial activity value of 2.0 or more.
² Test Laboratory: BOKEN / Test Report Number: 213251774-2, 213237371-2 / Test Method: JIS Z 2911 / Test Object: Shower Lifter and Door Gasket / Test Result: Mould resistance display 0.
³ Applicable when downloading. With registration of the washing programs in the washing machine, you can operate without the application. You can save one favourite program and change it depending on your needs.

Dimensions (mm)

BD-D120XGV / BD-120XGV

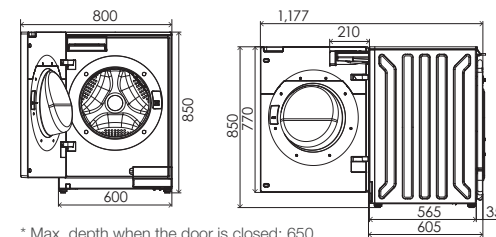

BD-D120GV / BD-D100GV / BD-120GV / BD-100GV

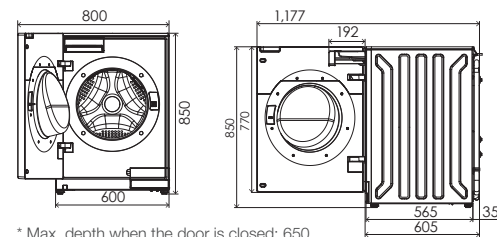

* Max. depth when the door is closed: 650

* Max. depth when the door is closed: 650

		Auto Self Clean Series					
Model		BD-90XFV	BD-90YAV	BD-W90AV	BD-W85AAE	BD-W75AAE	
Washing Capacity (kg)		9.0	9.0	9.0	8.5	7.5	
Inverter Control		●	●	●	-	-	
Washing Functions	Washing Process	3D Sensor Control Wash					
	Intelligent Sensor Systems	Water Level Sensor	●	●	●	●	●
		Water Temperature Sensor	●	●	●	●	●
		3D Vibration Sensor	●	●	-	-	-
		Load Sensor	●	●	●	●	●
		Revolution Sensor	●	●	●	●	●
		Foam Detection Sensor	●	●	●	●	●
	Vibration Control System	4-Ply Liquid Load Balancer	●	●	●	●	●
		Hydraulic Suspensions	●	●	●	●	●
	Self Correction System		●	●	●	●	●
Max. Spin Speed (r/min)		1,600	1,200	1,000	1,200	1,200	
Variable Spin Control		●	●	●	●	●	
Useful Functions	Tangle-Free Finish	●	●	●	●	●	
	Memory	●	●	●	●	●	
Clean Functions	Timer	●	●	●	●	●	
	Option	Water Temperature	Cold / 30°C / 40°C / 60°C / 90°C	Cold / 30°C / 40°C / 60°C / 90°C	Cold / 30°C / 40°C / 60°C / 90°C	Cold / 30°C / 40°C / 60°C / 90°C	Cold / 30°C / 40°C / 60°C / 90°C
		Spin Speed (r/min)	0 / 400 / 800 / 1000 / 1600	0 / 400 / 800 / 1000 / 1200	0 / 400 / 600 / 800 / 1000	0 / 400 / 600 / 800 / 1000	0 / 400 / 600 / 800 / 1000
	Intensive	●	●	●	●	●	
	Prewash	●	●	●	●	●	
	Extra Rinse	●	●	●	●	●	
	Rinse Hold	●	●	●	●	●	
	Auto Self Clean (Allergy UK Approved)	●	●	●	●	●	
	Tub Clean	● (40°C)	● (40°C)	● (40°C)	● (40°C)	● (40°C)	
	Antibacterial Material	Shower Lifter Gasket	Shower Lifter Gasket	Shower Lifter Gasket	Shower Lifter Gasket	Shower Lifter Gasket	
Door Clean	●	●	●	●	●		
Washing Programs	No. of Program	16	16	16	16	16	
		Cotton / Mix Daily 45 / Rapid 15 Synthetic / Delicate Outdoor / Duvet Crease Care Cotton Eco / Wool Allergy Care Tub Clean Rinse & Spin Spin / Drain	Cotton / Mix Daily 45 / Rapid 15 Synthetic / Delicate Outdoor / Duvet Crease Care Cotton Eco / Wool Allergy Care Tub Clean Rinse & Spin Spin / Drain	Cotton / Mix Daily 60 / Rapid 15 Synthetic / Delicate Outdoor / Duvet Crease Care Cotton Eco / Wool Allergy Care Tub Clean Rinse & Spin Spin / Drain	Cotton / Mix Daily 45 / Rapid 15 Synthetic / Delicate Outdoor / Duvet Crease Care Cotton Eco / Wool Allergy Care Tub Clean Rinse & Spin Spin / Drain	Cotton / Mix Daily 45 / Rapid 15 Synthetic / Delicate Outdoor / Duvet Crease Care Cotton Eco / Wool Allergy Care Tub Clean Rinse & Spin Spin / Drain	
Structure	Heat Protective Cover	●	-	-	-	-	
	Control Panel	LED / Knob	LED / Knob	LED / Knob	LED / Knob	LED / Knob	
	Detergent Drawer	All-in-One	All-in-One	All-in-One	All-in-One	All-in-One	
	Softener Drawer	-	-	-	-	-	
Reload		●	●	●	●	●	
Standby Power Zero W		●	●	●	●	●	
Auto Restart		●	●	●	●	●	
Auto Power Off		●	●	●	● (Semi)	● (Semi)	
Child Lock		●	●	●	●	●	
Safety lock		●	●	●	●	●	
Energy Consumption (kWh / Cycle)*1		0.74	0.86	0.74	0.98	0.92	
Water Consumption (L / Cycle)*1		44	44	42	41	32	
Dimensions (mm)*2	Width x Depth x Height	600 x 850 x 624	600 x 850 x 624	600 x 850 x 624	600 x 850 x 624	600 x 850 x 584	
	Without Worktop	600 x 820 x 624	600 x 820 x 624	600 x 820 x 624	600 x 820 x 624	600 x 820 x 584	
Minimum Installation Dimensions (Width x Depth x Height, mm)		606 x 823 x 603	606 x 823 x 603	606 x 823 x 603	606 x 823 x 603	606 x 823 x 563	
Body Colour		Metallic Silver	White	White	White	White	
Weight (Net / Gross, kg)		63 / 67	63 / 67	63 / 67	67 / 71	66 / 70	

*1 Based on COMMISSION DELEGATED REGULATION (EU) No 1061/2010
*2 Including drain hose and water supply hose

9.0 / 8.5 kg

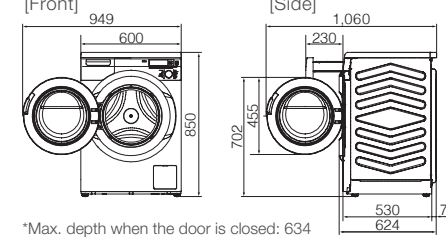

*Max. depth when the door is closed: 634

7.5 kg

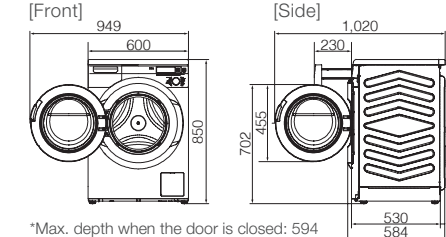

*Max. depth when the door is closed: 594