

Instruction Manual

HITACHI

Washing Machine

Fully Automatic

Model

LTL 10MVW0T

LTL 12MVW0T

LTL H3MVW0T

LTL 15MVW0T



Thank you for purchasing a Hitachi fully automatic washing machine.

- Please read this Instruction Manual carefully for proper operation of the machine.
- Please keep this Instruction Manual for future reference.

■ Quick access

If you would like to know the specifics of the error code, please access scan the code.



Contents

1. Environmentally Friendly Waste Disposal	3
2. Hints and Tips for Eco-friendly Washing.....	3
3. Safety Instructions	3
4. Parts and Accessories	6
5. Install the Washing Machine	7
6. Control Panel and Display	12
7. Preparation Before Use.....	14
8. Using the Washing Machine.....	14
9. Program Overview	19
10. Care and Maintenance	27
11. Troubleshooting	28
12. Error Codes	29
13. Specifications	30

For household use only

EN

TH ONLY

Please read this instruction manual first!

Dear Customer,





Thank you for choosing Hitachi product. We hope that you get the best results from your product which has been manufactured with high quality and state-of-the-art technology. Therefore, please read this entire instruction manual and all other accompanying documents carefully before using the product.

Follow all warnings and information in the instruction manual. Thus, you protect yourself and your product against possible dangers.

Keep the instruction manual. If you hand over the product to someone else, provide the Instruction manual as well. Warranty terms, usage and troubleshooting methods of your product are in instruction manual.

Symbols and Definitions

The following symbols are used in the instruction manual:

	Danger that could result in death or injury.
	Important information or useful hints about usage.
	Read the instruction manual.
	Recyclable materials.
	Hot surface warning.
WARNING	Danger that may result in property damage to the product or its environment.

1. Environmentally Friendly Waste Disposal

Disposing of the packaging

The shipping package has protected your new washing machine on its way to your home. All materials are ecologically harmless and recyclable. Please contribute to a better environment by disposing of packaging materials in an environmentally conscious manner.

Ask your dealer about current means of disposal.

Risk of choking!

Do not let children play with packaging and associated parts.

There is a risk of suffocating with plastic bags and collapsible boxes.

Disposing of your old appliance

You can dispose your old appliances. Environment-conscious recycling can reclaim them to valuable new materials.

Risk of death!

To dispose the old appliances:

1. Unplug the power plug from appliances you are no longer using.
2. Cut off the power cord and dispose of it with the plug.

If you wish to discard this product, contact your local authorities or dealer and ask for the correct method of disposal.

2 Hints and Tips for Eco-friendly Washing

- Keep the load limit of each program.
- This washing machine features power-saving operations with a built-in inverter controller which enables the machine to optimize operations according to the conditions of your clothes.
- Add detergent according to the degree of soiling, laundry size, and water hardness. Follow the detergent manufacturer's instructions regarding the amount of detergent to use.
- You can use further enhanced water-saving technology such as "Spin Shower Rinse". Water consumption is less than the former models.

3. Safety Instructions

- This appliance is intended to be used in household and similar applications such as: (IEC 60335-2-7)
 - Staff kitchen areas in shops, offices and other working environments;
 - Farm houses;
 - By clients in hotels, motels and other residential type environments;
 - Bed and breakfast type environments;
 - Areas for communal use in blocks of flats or in launderettes.



WARNING!

- Issues which may cause death or serious injury.

General safety

- Do not dismantle, repair or modify the washing machine. This could cause malfunction, fire, electric shock or injury. Contact your local service center for repairs.
- Do not put fire sources or anything inflammable in or near the washing machine (gas, diesel, petroleum, thinner, alcohol, or clothes stained with these substances). This could cause an explosion or fire.
- Do not pour water on the washing machine during operation. This could cause an electric shock.
- Do not climb on the washing machine. Do not place heavy object, drop any object or apply impact on the lid glass. This could cause lid glass breakage. If any scratch or breakage is found on lid glass, stop using the washing machine and contact your local service center to request inspection and repair.
- Do not forcibly open the lid during operation: Lid Lock Switch is designed to prevent from opening the lid during operation. This is because touching the washing tub while it is spinning may result in serious injury. If you can open the lid during operation, please stop using the Washing Machine immediately and refrain from touching the inside. Contact your local service center for repair.
- This appliance is not intended for use by persons with reduced physical, sensory or mental capabilities, or lack of experience and knowledge (including children) unless they have been given supervision or instruction concerning use of the appliance by a person responsible for their safety.
- If there is a water outage or if you are removing the water supply hose to reattach it, close the tap and press the Start/Pause button, then wait 40 seconds and slowly open the tap. Air pressure from a large amount of air in the water pipes

- may damage the washing machine.
- Periodically check that the union nut on the water supply hose is tight. A loose nut may cause a water leak.
- Remove the power plug from the outlet and close the water tap if you will not use the washing machine for a long time.

- Use the accessory hose provided with the machine. (Reusing old hoses can cause water leakage and property damage)



- The opening must not be obstructed by carpeting if the washing machine is installed on a carpeted floor.

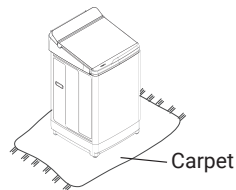

Installation

- Do not install it in a bathroom or a place exposed to rain. (This may cause corrosion, or current leakage and electric shock to the product)

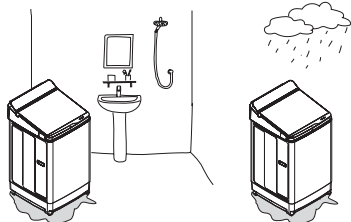

- Do not install it on a board with castors or an uneven surface. (This may cause vibration and noise)

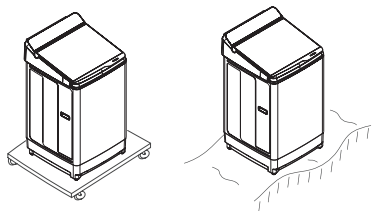

- Grounding must always be performed.

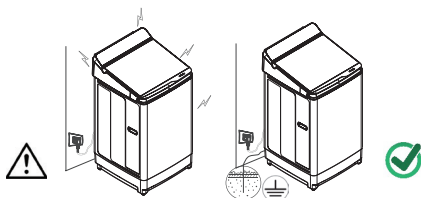

Power source and cord

- Use an outlet and a rated voltage of 220-240V 50Hz.

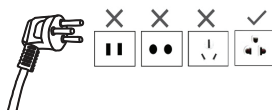

- Do not insert or remove the power plug with wet hands. (This could cause an electric shock)

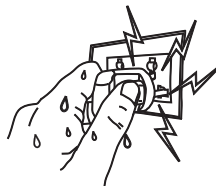

- Clean off any dust on the power plug. (It may cause a fire)

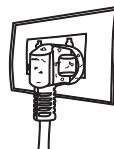

WARNING!

- If not grounded, current leakage, electric shock and product damage might occur.
- Use a 3-pin socket (Line, Neutral and Ground) for connection.
- Do not use an extension cord or double adapter.

- Do not tear, cut, modify, bend, pull or fold the power cord, etc. The damaged power cord can cause fire, electric shock.

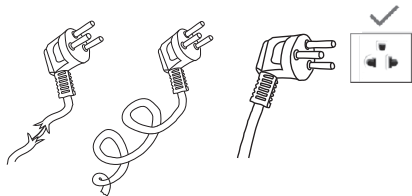

- Do not connect plugs to the same outlet and a loose, damaged one. (This may cause a short circuit or fire)

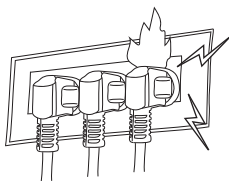

- * If the power cord is damaged, contact a dealer or repair shop authorized by the manufacturer to replace it to avoid risks.

Child safety

- Keep packaging out of reach of children and infants. Danger of suffocation.
- Do not let children climb onto the washing machine or to get into the tub. Do not leave boxes or chairs near the washing machine that children could use to climb onto it. This may cause injury.
- Children should be supervised to ensure that they do not play with the appliance.



CAUTION!

- Issues which may cause injury or damage property.

Use

- All packaging materials must be removed before using the washing machine. This may cause malfunction or abnormal vibration.
- Check inside the tub before operating the washing machine. Check that no pets or small animals are in the tub.
- Do not wash items through which water does not flow easily such as raincoats, wet suits, ski suits, sleeping bags, cushions, pillows, shoes, shower curtain. The washing machine may not work properly, or it may cause injury or damage the washing machine.



INFORMATION

- For more information, refer section 2 on page 14 "WARNING!"

- Do not fold and stack large items such as blankets together when washing them.
- Do not use a laundry net that is larger than 40cm on a side. The clothes may become off balance and cause abnormal vibration during the spin cycle.
- Do not load laundry over the lower part of the liquid load balancer (dashed line). This may cause laundry to fly out of the tub during the spin cycle and damage the clothes or the washing machine, or cause a water leak.



INFORMATION

- For more information, refer on page 14 "Sort the laundry"

- Always put detergent into the detergent dispenser when washing laundry.
- Do not use water hotter than 50°C.
- Do not wash items together with coins, pins, or stones. This may damage clothes or the washing machine, or cause a water leak. Check inside pockets before washing.
- Do not press the buttons with sharp pointed objects.
- Do not put heavy objects, liquid-filled containers or equipment which produces heat on the washing machine. This may damage the washing machine or its top.

Care and maintenance

- If detergent, fabric softener or bleach spills on the surface of the machine, clean it up with a damp cloth immediately. The plastic or steel parts of the washing machine may be damaged.
- Do not place equipment that produces heat near the washing machine. This may cause deformation of the washing machine.

4. Parts and Accessories

Tub

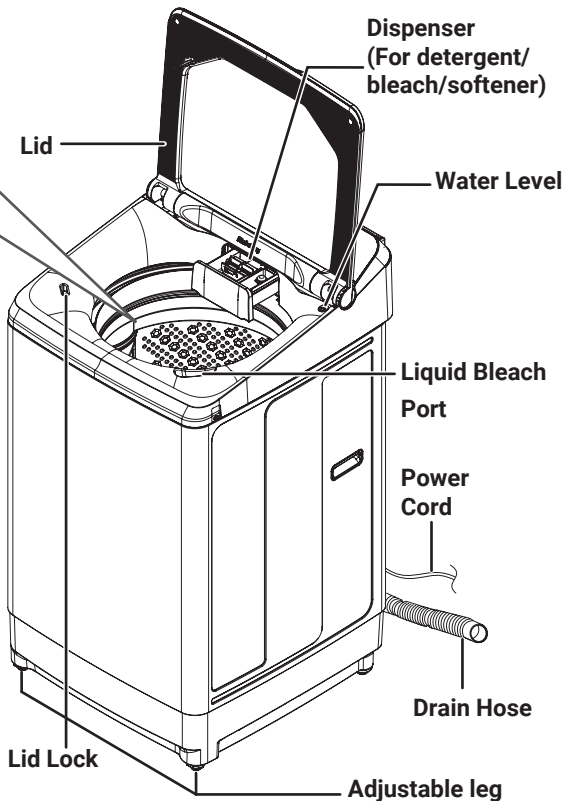
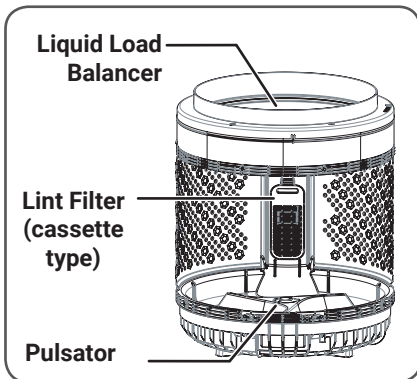

Dispenser

When you use Powder Detergent

Move the detergent trap to the rear position as shown below.

Powder Detergent/Powder Bleach Dispenser

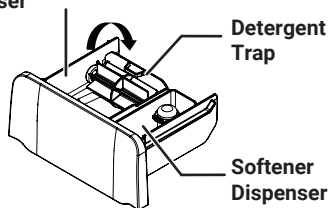

When you use Liquid Detergent

Move the detergent trap to the front position as shown below.

Liquid Detergent Dispenser

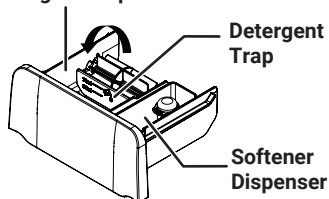

Dispenser

When you use Liquid Bleach

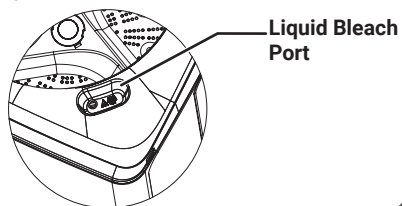

Accessories

Water Supply Hose and Joint



(1 Set)

Rat Guard



(1 Piece)

Drain Hose



(1 Piece)

Optional accessories

Laundry Net



Refer to page 18
Part number PTSF-140JJS 001

5. Install the Washing Machine

Safety precautions

- Do not use a damaged power plug for your safety. Contact a repair center that is certified by the manufacturer to replace the plug.
- If the outlet you are using is a 2-pin outlet, use an adapter to change from three pins to two pins. When you do this, be sure to connect an earth wire. There are risk of electric shock, electronic substrate and electronic parts damage if you do not connect an earth wire.
- Do not connect an earth wire to a gas pipe, telephone wire, water pipe, or lightning rod. Remove the power plug from the electric outlet when you are attaching an earth wire.
- You do not need to attach an earth wire if the electric outlet is a 3-pin type with earth terminal.

Area	Gap
Left	At least 9 cm
Right	At least 9 cm
Rear	Should be 10 cm or more for the rear with the Water Supply Hose.

Where to install the washing machine

- The hoses may be damaged if they are frozen. Do not install the washing machine outside or any other place with a risk of freezing.
- Install the washing machine on a solid level floor to avoid excessive vibration and noise.
- Do not install the washing machine in an extremely humid place, such as a bathroom or a place exposed to rain.
- Do not install the washing machine in a slippery or unstable location. Doing so could cause abnormal vibration.
- Install the washing machine away from walls as shown below to avoid abnormal noise and vibration.
- Drain Hose can be moved by the pressure of drain water or the vibration. If the drain port is big or shallow, please fix drain hose so that it does not come off.

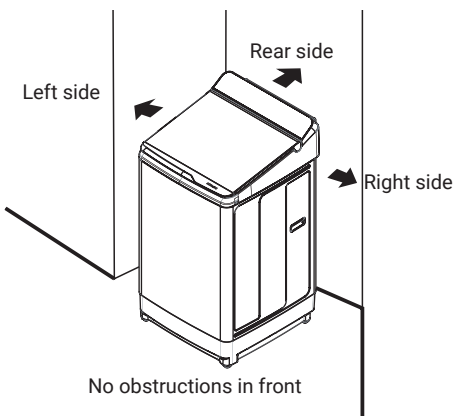

Install The Rat Guard

1. Before inserting "Rat Guard", Please check that it is as shown in the figure below.
2. Tilt the machine back approximately 30 degrees. Set this parts into the guide at front side of body and push into forward.

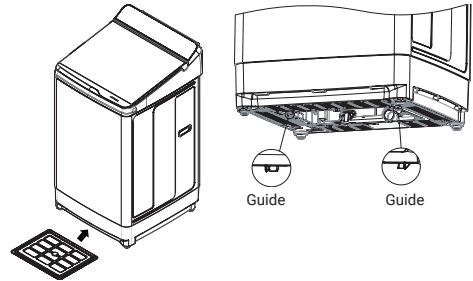

3. Use the knob of hook lock to bend and push "Rat Guard" in.

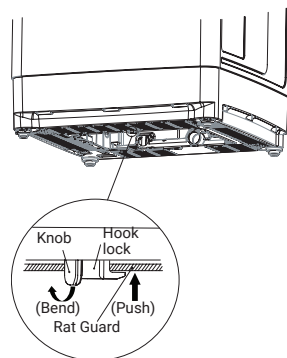

Installing the drain hose

The drain hose is fully extended. If not fully extended the hose will cause any problems, such as water trapped in a pipe.

Push the drain hose into the connection port and hold it tightly with the hose clip (enclosed in the package.)

- Hose clip (set it correctly in the direction indicated in the figure)

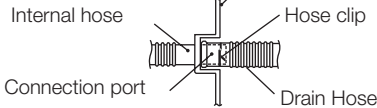
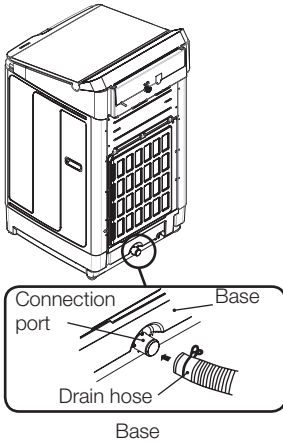

Insert the end of the drain hose into the drain outlet.

- Do not allow the drain hose to be bent, twisted, pulled out and damaged, stepped on, or crimped.
- Spread a cloth on the ground before laying the washing machine down on its back to prevent damaging it.
- Use a knife to cut the end of the drain hose at a 45 degree angle because if the drain channel is shallow and the end of the drain hose is blocked, it could cause a malfunction.
 - Is it firmly installed to the drain outlet, elbow pipe connector and drain trap?
 - Is the end of the drain hose blocked?
 - Is the hose piece installed to the end of the drain hose?

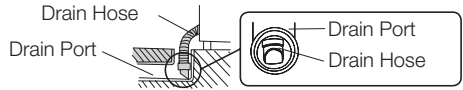
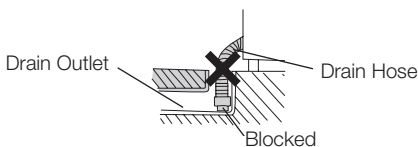

- Is the drain hose bent?
- Keep the top of the drain hose no more than 10 cm above the floor if it crosses a door sill or something else. If it is higher than this, the water has difficulty draining and a "C2" error (water does not drain) may occur.
- Do not extend the drain hose more than 2 meters from the washing machine.
- For good draining effect, please follow below. In case of using the general extension hose, if inner diameter of hose is small, it cannot drain water efficiently and the unit may not work normally.
 - Is the end of the drain hose coming off due to the force or vibration of the drainage water?
 - Is the height of the drain hose exceeding more than 10 cm and the total length of the drain hose exceeding more than 2 m?

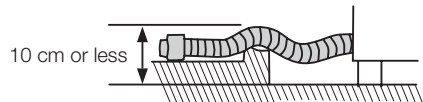
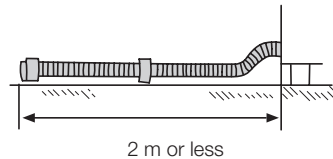

Connecting to the tap

- Water supply hose



- The optimum water pressure is 0.03 to 0.8 MPa.

Horizontal tap



Extension tap



Hose connector

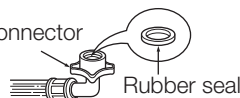

- Check that the rubber seal is in the hose connector.

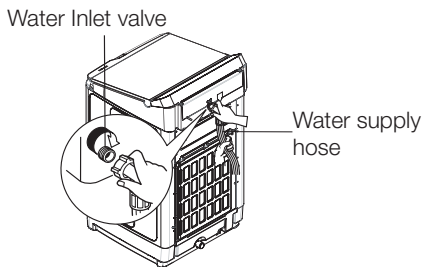

- Connect the water supply hose to the water supply inlet on the washing machine.
- Water supply hose with faucet connector
Loosen the top connector.
 - If the diameter of the tap is larger than the connector ring, remove the ring.

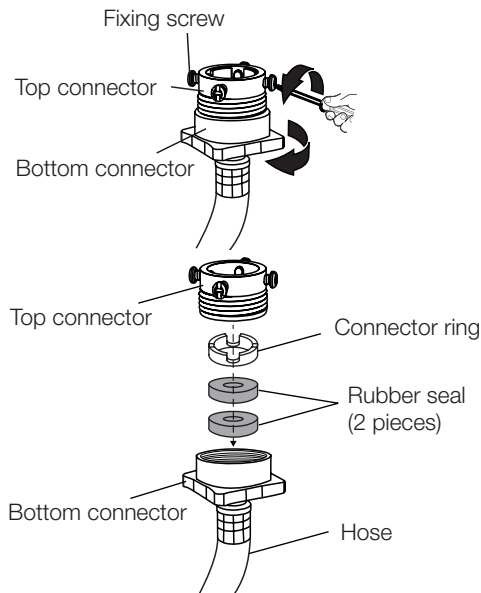

CAUTION!

- If only one rubber seal is assembled, it will cause water leaks.

Press up on the top connector so the rubber seal and the tap are firmly sealed. Next, tighten the 4 screws.

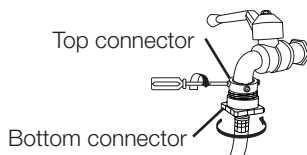

- Rotate the bottom connector so there is no water leakage.
- To remove the water supply hose from the top connector, close the tap. Next, rotate off the bottom connector.

Attach the water supply hose by rotating the bottom connector to the top connector.

- Make sure the union nut between the water supply hose and the washing machine is firmly tightened.
- Before operating the washing machine, open the tap to confirm that the water supply hose is correctly connected. If the union nut is loose, water will leak.

Installation of Washing Machine

- Move the Washing Machine to the setting area.
- Connect the Washing Machine correctly to a grounded AC power supply.
- The voltage of the power supply must match the voltage rating of the Washing Machine.
- Do not use extension cords or overload the power outlet by using power strips.

Check the horizontal level

Check the "Water Level" to make sure it is level. Adjust the following condition for details how to adjust, please refer to the next section, "Adjust the level"

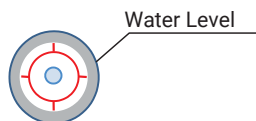

The water level is in the center position.



CAUTION!

The following conditions require adjustment

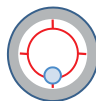

Adjust the back higher



Adjust the front higher

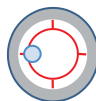

Adjust the right side higher

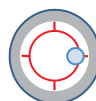

Adjust the left side higher

Adjust the level

- If the Washing Machine is not stable or when the floor itself is not leveled, please adjust the leg to stabilize the washing machine.

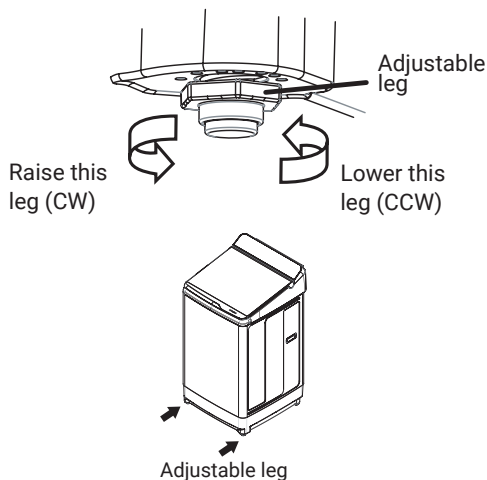

Check the center of tub

- When the Washing Machine is leveled, please also make sure that the washing tub is positioned approximately in the center.



Check the difference between left and right

NOTES

- If the Washing Machine is not stable or the floor itself is not leveled may cause a vibration or abnormal operation and code "C04" show on display.

Checking after installation

If any of the following problems or other abnormalities occur, immediately unplug the power plug and contact your local service center.

- The Washing Machine does not operate when the power is turned on.
- The power cord is damaged.
- There are abnormal vibrations or sounds during operation.
- There is a smell of burning.



CAUTION!

Perform "Trial operation" before the first wash.

Trial Operation Procedure:

After installation is completed, perform a trial operation following the procedure below and confirm that there is no unusual sound or water leakage and that water drains smoothly. Perform a test run for approximately 10 minutes.

1. Close the faucet of water supply hose.

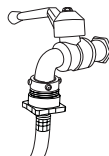

2. Press On/Off button.

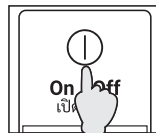

3. Press and hold the "Wash mode" button and the "Program" button together.

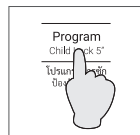
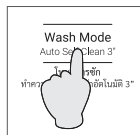

4. "777" is displayed on the operation time display.



5. Press the Start/Pause button to start operation.

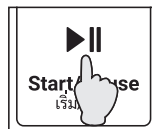

6. Open the faucet of water supply hose.

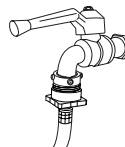

7. The following steps are performed:

- (a) Sensing => (b) Water supply => (c) Stirring =>
(d) Drain => (e) Spin

Check item at each process

- Confirm that "35L" is displayed in the sensing result.
 - Check if there is no abnormal noise while the pulsator is rotating.
- When water is supplied, check if water is leaking at the water supply hose or its connection.

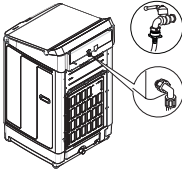

- Check that there is no water dripping, except from the main body of the washing machine
- Check that water is flowing from the drainage hose
- Make sure that the drainage hose is not crawling in such a way that it obstructs the drainage

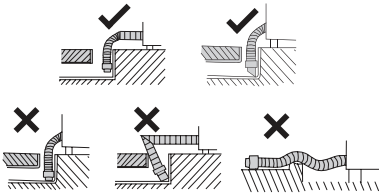

- Check for any unusual noises or vibrations during dehydration.

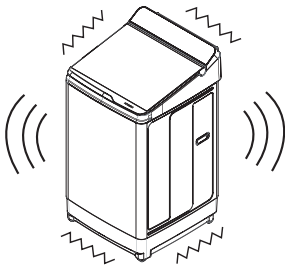

Customer Service

If the washing machine malfunctions, check the Instruction Manual thoroughly before you call for repairs.

If you are unable to identify or solve the problem, contact your local service center.

When you call the service center, you will need to tell them the model of the washing machine, describe the malfunction, and give them your address and phone number.

6. Control Panel and Display

During Operation (lid closed)

NOTES

- Directly press the buttons on the Control Panel.

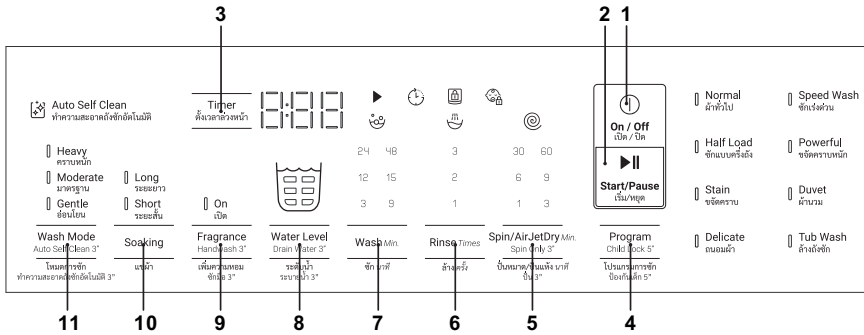

1. On/Off button: To switch power on and off, press this button. (when power on, 1 time and display is on). The washing machine automatically switches off when operations are finished. The washing machine turns off automatically if it is not operated for 10 minutes after the power has been turned on.

2. Start/Pause button: To start or pause the operation, press this button. When the washing machine is paused for over 24 hours without any operations, it turns off automatically.

3. Timer button: The operation select the time to finish washing. You can choose from 3 to 12 hours. This cannot be set in the Tub Wash program. After setting is complete, you can reconfirm your settings by pressing "Timer"
Note : It is recommended to use powder detergent instead of liquid detergent for this function.

4. Program button: To select a program, press this button. The program changes each time you press the button.

Child lock button (Hold5s): To prevent accidental operation by children, the unit always lock the lid. Press the Program button hold 5 seconds to activate this option. The symbolis show on the display. Press Program button hold 5 seconds again to cancel the child lock. While the machine is running, to cancel the Child Lock. Press the stop button (Start/ Pause) first and then press and hold the "Program" button for 5 seconds to cancel the Child Lock function.

Note : The lid lock remains ON even if the machine is stopped or operation is terminated during operation, unless the Child lock is released.

5. Spin/AirJetDry button: To change the spin time, press this button. You can set the spin time between 1 and 60 minutes.

Tips :

AirJetDry 30 min : For synthetic clothes

AirJetDry 60 min : For cotton clothes

Spin Only button (Hold3s): Shortcut key for dehydration alone operation. After pressing and holding, the display will show dehydration only. Select the desired dewatering time and start.

Note : Make sure that the clothes are not unbalanced. An error will occur if the balance is not right.

6. Rinse button: To change the rinse times, press this button.

7. Wash button: To change the washing time, press this button.

8. Water Level button: You can set the amount of Water each time you press the Water Level button.

Drain Water button (Hold3s): If you only want to drain water, use "Drain Water". After setting "Drain Water", press the Start button to start draining. Unlike Spin, the basket does not rotate. When the machine stops draining, the end sound will be heard and the power will be turned off.

9. Fragrance button: This function is designed to make the fabric softener more effective.

This function is recommended for those who want to soften clothes and retain some of the fabric softener's scent.

This cannot be set in the Tub Wash program.

Note 1: The operation time varies depending on the program and the amount of clothes.

Note 2: The dewatering speed is lower than normal operation, so some water will be left on the clothes.

Note 3: If unbalance occurs during final spin, water will not be supplied to balance the clothes : if a C4 error code occurs, please make sure the clothes are evened out.

Handwash button (Hold3s): Use this function when you want to handwash your own clothes. As soon as "Handwash" is set, the water supply starts.

When the water level reaches 33L, it will start draining.

Draining continues until the water level reaches 25L

In the meantime, water supply continues. Press and hold "Handwash" again to stop water supply.

Note 1: This function automatically stops after 1 hour.

Note 2: The water does not drain automatically. If you only want to drain the water, use "Drain Water".

You can use the water in the tub for other programs, but if the water already contains detergent, please reduce the amount of detergent.

10. Soaking button: A soaking process can be added. Select "Short" or "Long" depending on the amount of soiling. Up to 60 minutes will be added.

11. Wash Mode button: You can freely change the strength of agitation. Select "Heavy" for strong washing. Select "Gentle" for a gentle washing. This function is not available for some programs : Powerful, Duvet and Tub Wash.

Auto Self Clean button (Hold3s): Each time the machine is operated, it performs an automatic washing operation of the tub. The operation is performed after the rinse is completed.

Note : This function is not available for some programs: Delicate, Duvet, Tub Wash.

Displays all cycle Information, remaining time and error codes.

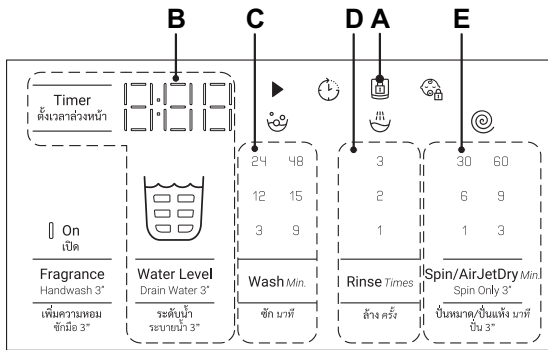

- A.** Lid lock  : The Lid is locked when this symbol is lighted.
- B.** Adjust the "Water Level" of program (shown as 'Water Level') Remaining time of the program (shown as 'Time Left')

- C.** Washing time
- D.** Rinse times
- E.** Spin time

Symbols on control panel



7. Preparation Before Use

1. Preparing the laundry

- Remove foreign objects, if any (coins, safety pins, etc.).
- Put delicate clothes (knits, lingerie, etc.) in a net.
- Remove large lumps of lint, mud, sand, hair, and pet hair from laundry, if any.
- Tie strings and close fasteners, if applicable.

2. Sorting the laundry

- Sort laundry according to the fabric type and care label symbols (cottons, blended fabrics, synthetics, wool, hand washable items, etc.).
- Do not wash extremely small loads, such as only a pair of jeans.
 - This may cause abnormal vibration during the spin cycle.
- Separate colored and white items.



WARNING!

Do not wash the following items through which water does not flow easily, because doing so creates abnormal vibration during the spin cycle and may cause injury or malfunction.

- Waterproof items, such as wetsuit, ski suit, shower curtain, sleeping bag, raincoats, diapers, diaper covers, bicycle covers, motorcycle covers, car covers, carpets, waterproof seat cushions, waterproof bedding cover, foot pads and other hard and thick items, (Even though “the care label” mentions that it can be washed by the washing machine, but please do not put them in the washing machine for washing).
- Anti-slip treated items with rubber bottoms such as a doormat.
- Cushions, pillows, shoes, etc.

Detergents and additives

- Use an appropriate amount of detergent according to the detergent indicator of the washing machine. The type and amount of detergent vary depend on the fabric type, volume, load size, degree of soiling, and hardness of the water used.

Use less detergent if:

- The load is small.
- The laundry is not very dirty.
- Too much detergent may result in excess foam, which reduces rinse efficiency or may cause a water leak.
- Depending on the detergent brand, detergent may not dissolve completely in the detergent tray

if the water pressure is low or the water is too cold.

– Page 27: Care and Maintenance

- When using softeners or bleaches, follow the instructions on the package.



INFORMATION

- If the following happens, detergent may remain undissolved and remain on your clothes.
 - If you have too much laundry
 - If the amount of detergent is too much
 - When the water temperature is low
- If you wish to use powdered detergent, we recommend that you dissolve the powdered detergent in water before using to avoid this.
- If you dissolve powdered detergent in water, you should pour it directly into the tub, as it won't fit in a regular dispenser.
- If water pressure is unstable during operation, it may cause the water remaining in Detergent and Softener box.

8. Using the Washing Machine

1. Sort the laundry

- Sort the laundry according to the type of fabric, care label symbol, and degree of soiling.
 - Page 14: Preparing the laundry
- Do not exceed the maximum load.
- Laundry shall not exceed this dashed line. Otherwise, laundry may jump out from the washing tub while spinning and it may cause damage.

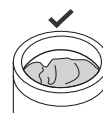
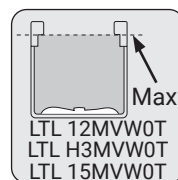
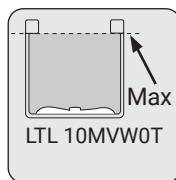

2. Press the Power button to turn on the power

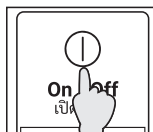

- If no program is operated within 10 minutes, the washing machine automatically switches itself off. Press the Power button again to turn on the power.

3. Select and adjust the program

- Select a program with the Program button.
 - Page 20: List of Programs
- You can change the pattern or settings of wash, rinse, and spin operations by the Wash, Rinse, and Spin buttons.
- You can activate the “Auto Self Clean” function by press and hold the “Wash Mode” button for 3 sec.
 - Page 16: How to use the “Auto Self Clean” function
 - Once switched on, the “Auto Self Clean” function operates every time you do your laundry. To deactivate, press the same button again while the power is on.
 - Refer “6. Control Panel and Display” on page 12 for an overview of other functions.

Set the operations

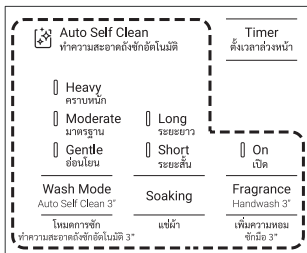

Select a function.

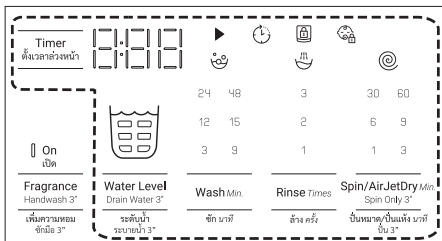

Change the pattern or settings of Wash, Rinse, Spin and others.



Select a program.

4. Put detergent into the detergent dispenser and close the lid

- Open the detergent dispenser, add the amount of detergent shown on the package, and then close the detergent dispenser.
- The amount of detergent is based on a single 35-gram scoop of powder detergent. Since the required amount of detergent varies depending on the type of detergent, follow the instructions on the package of detergent.

5. Press the Start/Pause button

- Before operation starts, the laundry is weighted. Then, the necessary amount of water shall be displayed.

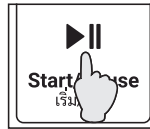

INFORMATION

- If the following happens, detergent may remain undissolved and remain on your clothes.
 - If you have too much laundry
 - If the amount of detergent is too much
 - When the water temperature is low
- If you wish to use powdered detergent, we recommend that you dissolve the powdered detergent in water before using to avoid this.
- If you dissolve powdered detergent in water, you should pour it directly into the tub, as it won't fit in a regular dispenser.

- For liquid detergent, follow the instructions on the package and add it to the liquid detergent dispenser.
- Add softener to the softener dispenser according to the instructions on the package of softener. Then, softener shall be added to the tub automatically during the final rinse.
- The speed at which the lid is locked may vary, depending on the temperature; however, this is not an abnormality.

5.1 Pausing a program

Press the Start/Pause button. The washing machine will switch itself off if it is not restarted within 24 hours.

5.2 Adding clothes partway through a program

Press the Start/Pause button to pause operation and add your clothes. The lid is locked while the tub is spinning, so wait until the tub stops completely and the lid lock is automatically released. After adding the clothes, close the lid and press the Start/Pause button to restart the operation.

* **Note** : It is not recommended to add a large amount of clothes as the washing machine first measures the load size to determine optimum operation.

5.3 Terminating a program

Press the Start/Pause button, then press the Power button to turn off the power.

6. Take out the laundry (End of the program)

- The alarm sounds when a program ends.
- The washing machine automatically switches off when the operations are finished. Open the lid and take out the laundry to dry.

- The alarm can be deactivated or the sound can be changed press and hold “Wash” button to change the melody sound at the end.

When you press and hold the “Wash” button, the demo sound at the end will be played.

It is also possible to set the “Mute” setting. If you set to “Mute”, all sounds except the error sound will be silent.

Melody1(Default) -> Melody2 -> Melody3
-> Mono sound1 -> Mono sound2 -> Mute mode(pip sound) -> Return to Melody1

Using the Functions and Programs

Auto Self Clean function

1. To turn on the power, press the On/Off button.
2. Select a program.
3. Press and hold the “Wash Mode” button for 3 sec.
4. Press the Start/Pause button.

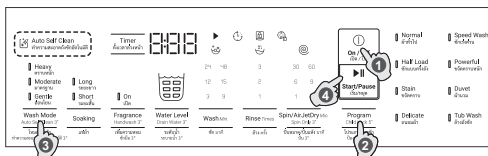

- This setting is switched off at the time of shipment from factory. Once activated, the “Auto Self Clean” function operates every time you do your laundry.

- Prior to the final spin cycle, the outside of the tub, the back side of the pulsator, and the inside of the outer tub are washed to eliminate dirt and mold.
- To deactivate the “Auto Self Clean” function, press and hold the “Wash Mode” button for 3 sec again while the power is on.

INFORMATION

- Runs just before the spin cycle begins in each program,
- Runs even when the washing machine has started operation from rinsing,
- Cannot be set or cancelled during operation,
- Automatically cancelled when:
 - No washing and no rinsing are set.
 - No rinsing is set.
 - No spinning is set.
- May not wash some dirt depending on the type and degree of dirt,
- May not wash some dirt If the washing machine is seldom used.

- To clean the tub more completely, we recommend using the Tub Clean program along with the “Auto Self Clean” function.
- The “Auto Self Clean” function is deactivated when one of the following programs is selected.
 - Duvet
 - Tub Wash
 - Delicate

Handwash function

First, do not put detergent or fabric softener in dispenser as water will flow into it.

1. To turn on the power, press the On/Off button.
2. Press and hold the “Fragrance” button for 3 sec.



3. The water supply start.
4. You can open lid and wash.
5. After use, wipe gently with a dry cloth to remove any splashes.

- When finished washing and want to stop the handwash function, press and hold the Fragrance button for 3 seconds to stop the operation.

Note 1 : Once a certain water level is reached, it will start draining, but this is not malfunction. If drainage is not possible for some reason, “C2” error will be displayed.

Note 2 : The water does not drain automatically. If

you only want to drain the water, use “Drain Water” function.

You can use the water in the tub for other programs, but if the water already contains detergent, please reduce the amount of detergent.



CAUTION

- While this function is in use, some amount of water will accumulate. Do not allow children to use this function to avoid choking by falling into the tub.

Drain Water function

1. To turn on the power, press the On/Off button.
2. Press and hold the “Water Level” button for 3 sec.

3. Press the Start/Pause button to start draining.

- Unlike Spin, the basket does not rotate. When the machine stops draining, a sound will be heard.

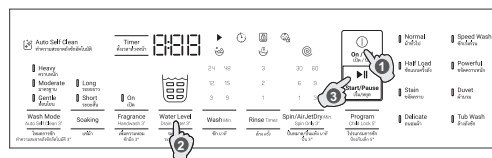

Timer Function

1. To turn on the power, press the On/Off button.

2. Select a program.

3. Press the Timer button and select the time to finish washing. Each press of the button starting from 3 hours to 12 hours later.

4. Press the Start/Pause button.

5. Add detergent and close the lid. The power turns off after a short time.

6. Operations finish at the set time.

- The Timer is unavailable for the Tub Wash programs.
 - To change the setting, press the On/Off button and do the settings again.
 - If there is a power outage while the timer is set, the timer setting is cancelled. If this happens, press the Power button again and reset the timer.
 - To prevent your laundry from wrinkling, take them out from the Washing Machine to dry once the operation is completed.
- Note :** It is recommended to use powder detergent instead of liquid detergent for this function.

Auto Restart Function

If there is a power outage

The washing machine is equipped with a restart function.

If a power outage occurs while the washing machine is operating, the cycle (i.e., wash, rinse, or spin) at that time is saved, and when the power is restored, automatically restart from the interrupted cycle.

If there is a power outage during the spin cycle, the lid is locked and cannot be opened. After the power is restored, the lock is released.

How to unlock the lid

In case of the lid does not unlock can not open operation normally, please the following step.

1. Pull the screw sheet out of the top cover.

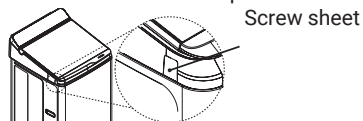

2. Remove the unlock cap from the top cover.

- Insert the tip of the screwdriver into the unlock port.
- Pry up to release the unlock cap.

Unlock cap

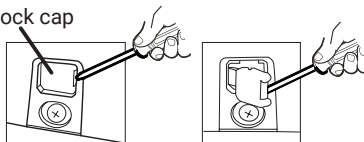

3. When the unlock cap is released from the top cover, pull the unlock cap parallel to the machine body towards the front as directed by the arrow to unlock the lock switch of the lid.

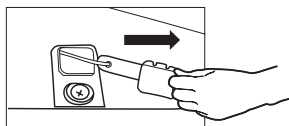

4. After unlocking the lid, install the unlock cap and the screw sheet to the top cover by reversing the order from (3) to (1).



CAUTION!

- When press-fitting the unlock cap back into its port, ensure that it is properly and tightly attached to the top cover.
- To re-install the unlock cap, make sure it is re-installed properly, otherwise lid locks may not work correctly.

Duvet program

1. Prepare the laundry.
- Use a laundry net for blankets when washing large items such as quilts, blankets, and sheets.

NOTES

- If you do not use the laundry net for washing, it may damage your clothes or damage the washing machine, household goods and code "C04" show on display.
- Fold large items such as quilts, blankets, and sheets as follows and put them in the laundry net.

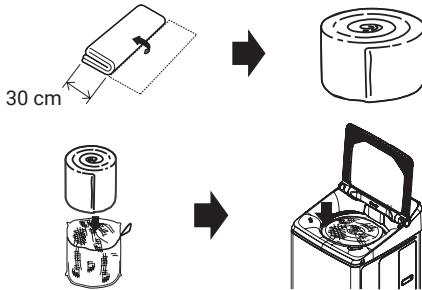

(Laundry net: Product number PTSF-140JJS 001)

2. To turn on the power, press the On/Off button.
3. Select the Duvet program.
4. Add detergent and close the lid.
5. Press the Start/Pause button.

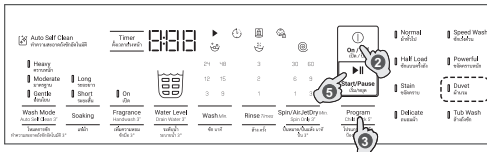

Stain program

1. To turn on the power, press the On/Off button.
2. Select the Stain program.

You can select the operation time by pressing "Soaking" button.

3h mode : for removing stains that are generally difficult to remove.

7h mode : for removing yellow stains.

INFORMATION

- When using the 7h mode, add twice the amount of powdered detergent recommended by the detergent package.
- If the normal amount of detergent is added, or if liquid detergent is added, the cleaning effect will be reduced.

Tub Wash program

INFORMATION

- Use this program separately from other washing programs. Do not put laundry into the tub.

1. To turn on the power, press the On/Off button.
2. Select the Tub Wash program.
3. Close the lid, and press the Start/Pause button. The washing machine starts pouring water into the tub.
4. When the water reaches about half the tub, press the Start/Pause button and open the lid, add tub cleaner to the tub by following the instruction given on its package.

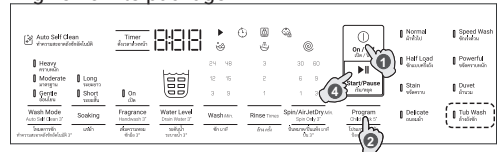

- The Tub Wash program can be set to 3 or 11 hours. At first, "3 hours" is set. Press the "Soaking" button again to set "11 hours".
- Water is added to the maximum level to wash away invisible dirt from both outer and inner tubs. Then, normal rinse operation will be performed twice to flush out any remaining dirt and tub cleaner.

Using liquid detergent and bleach

Liquid detergent

- Dilute liquid detergent and gently pour into the dispenser.
- When using washer timer, dilute liquid detergent twice.

Bleach

- Dilute bleach with water and gently pour into dispenser before washing starts.

INFORMATION

- Follow the instructions on package of liquid detergent or bleach for directions and usage amount.
- Do not put bleach directly onto laundry, it may lead to damages to the texture or discoloring.

9. Program Overview

Program	Type of Laundry / Notes	Model / Max Load			
		15MVW0T	H3MVW0T	12MVW0T	10MVW0T
Normal	For daily washing of cotton and linen items such as shirts, underwear, towels, bed linen and table linen.	15 kg	13.5 kg	12 kg	10 kg
Half Load	This program is controlled to wash less than half loads of clothing. This program is recommended for those who have less dirt but need a quick wash.	6 kg	6 kg	6 kg	5 kg
Stain	Wash clothes with a highly concentrated detergent solution using a small amount of water. This program is controlled to remove stains that are difficult to remove with regular laundry programs. 2 modes of operation are available. (3h mode and 7h mode)	6/2.5 kg	6/2.5 kg	6/2.5 kg	5/2.5 kg
Delicate	This is a gentle wash program for delicate items such as lingerie and thin lace curtains.	6.5 kg	6.5 kg	6 kg	5 kg
Speed Wash	This program lets you wash small loads of lightly soiled clothes and small items such as underwear.	2 kg	2 kg	2 kg	2 kg
Powerful	Recommended for those who want to wash even more thoroughly than the Normal program.	15 kg	13.5 kg	12 kg	10 kg
Duvet	For washable large items such as duvets, blankets, bedspreads, etc.	3 kg	3 kg	3 kg	3 kg
Tub Wash	This program is a maintenance program for washing tub. (3h mode and 11h mode)	-	-	-	-

List of Programs

: Default settings

: Changeable settings (via corresponding button)

Program		Normal	Half Load	Stain	
				3 hrs	7 hrs
Maximum load	15MVW0T	15 kg	6 kg	6 kg	2.5 kg
	H3MVW0T	13.5 kg	6 kg	6 kg	2.5 kg
	12MVW0T	12 kg	6 kg	6 kg	2.5 kg
	10MVW0T	10 kg	5 kg	5 kg	2.5 kg
Amount of water	15MVW0T	35 to 93 L (Adjusted auto)	50 L	35 to 50 L (Adjusted auto)	
		35 to 98 L	35 to 60 L	-	
	H3MVW0T	35 to 85 L (Adjusted auto)	50 L	35 to 50 L (Adjusted auto)	
		35 to 90 L	35 to 60 L	-	
	12MVW0T	35 to 70 L (Adjusted auto)	50 L	35 to 50 L (Adjusted auto)	
		35 to 88 L	35 to 60 L	-	
	10MVW0T	35 to 60 L (Adjusted auto)	50 L	35 to 50 L (Adjusted auto)	
		35 to 87 L	35 to 60 L	-	
Wash		15 min	3 min	2 hrs	6 hrs
		3, 9, 12, 15, 24 min or none	3, 9, 12, 15, 24 min or none	-	-
Rinse		2 times	1 time	2 times	
		1, 2, 3 times or none	1, 2, 3 times or none	1, 2, 3 times or none	
Spin		6 min	3 min	6 min	
		1, 3, 6, 9, 30, 60 min or none	1, 3, 6, 9, 30, 60 min or none	1, 3, 6, 9, 30, 60 min or none	
Required time (guide)	15MVW0T	45 to 63 min	29 min	3 hrs	7 hrs
	H3MVW0T	45 to 63 min	29 min	3 hrs	7 hrs
	12MVW0T	45 to 63 min	29 min	3 hrs	7 hrs
	10MVW0T	43 to 55 min	29 min	3 hrs	7 hrs
Option settings	Timer	0	0	0	0
	Auto Self Clean	0	0	0	0
	Wash Mode	0	0	0	0
	Fragrance	0	0	0	0
	Soaking	0	0	Use to select wash mode (3 or 7 hrs)	

Program		Delicate	Speed Wash	Powerful
Maximum load	15MVW0T	6.5 kg	2 kg	15 kg
	H3MVW0T	6.5 kg	2 kg	13.5 kg
	12MVW0T	6 kg	2 kg	12 kg
	10MVW0T	5 kg	2 kg	10 kg
Amount of water	15MVW0T	55 L	35 L	35 to 98 L (Adjusted auto)
		45 to 80 L	35 to 45 L	35 to 98 L
	H3MVW0T	55 L	35 L	35 to 90 L (Adjusted auto)
		45 to 80 L	35 to 45 L	35 to 90 L
	12MVW0T	55 L	35 L	35 to 88 L (Adjusted auto)
		45 to 78 L	35 to 45 L	35 to 88 L
	10MVW0T	55 L	35 L	35 to 87 L (Adjusted auto)
		45 to 77 L	35 to 45 L	35 to 87 L
Wash		9 min	3 min	48 min
		-	-	12, 15, 24, 48 min or none
Rinse		1 time	1 time	2 times
		1, 2, 3 times or none	-	1, 2, 3 times or none
Spin		3 min	1 min	6 min
		1, 3, 6, 9, 30, 60 min or none	-	1, 3, 6, 9, 3, 60 min or none
Required time (guide)	15MVW0T	33 min	19 min	52 to 97 min
	H3MVW0T	33 min	19 min	52 to 97 min
	12MVW0T	33 min	19 min	52 to 97 min
	10MVW0T	33 min	19 min	52 to 97 min
Option settings	Timer	0	0	0
	Auto Self Clean	X	0	0
	Wash Mode	0	0	X
	Fragrance	0	0	0
	Soaking	0	0	0

Program		Duvet	Tub Wash	
			3 hrs	11 hrs
Maximum load	15MVW0T	3 kg	*Do not put clothing in tub	
	H3MVW0T	3 kg		
	12MVW0T	3 kg		
	10MVW0T	3 kg		
Amount of water	15MVW0T	90 L	- (93 L)	
		75 to 90 L	- (93 L)	
	H3MVW0T	90 L	- (93 L)	
		75 to 90 L	- (93 L)	
	12MVW0T	90 L	- (93 L)	
		74 to 90 L	- (93 L)	
	10MVW0T	90 L	- (93 L)	
		74 to 90 L	- (93 L)	
Wash		24 min	2 hrs	10 hrs
		-	-	
Rinse		2 times	2 times	
		-	-	
Spin		9 min	- (30 min)	
		1, 3, 6, 9 min or none	-	
Required time (guide)	15MVW0T	80 min	200 min	694 min
	H3MVW0T	80 min	200 min	694 min
	12MVW0T	80 min	200 min	694 min
	10MVW0T	80 min	200 min	694 min
Option settings	Timer	0	X	X
	Auto Self Clean	X	X	X
	Wash Mode	X	X	X
	Fragrance	0	X	X
	Soaking	0	Use to select wash model (3 or 11 hrs)	

List of Programs

- The wash time and the spin time may change during the program depending on the weight and type of laundry being washed.
- The displayed times are guidelines. More time may be required depending on the water pressure and the type of laundry.
- Programs cannot be changed once they are started. To change them, turn the power off and then on again to re-select a program.
- The clear part of the lid and control panel may become foggy or may form dew on the edge of lid if you use hot water to wash your laundry; however, this is not an abnormality. Wipe it off after washing your laundry.
- Depending on the type of clothes, maximum loading amount may differ.
- Even if you set the delay timer, it may start soon according to the required time of the program.
- Water flow is adjusted automatically according to the amount of load and water level. When loads are heavy and water level is high, water flow is adjusted at slower rate to maintain the performance of washer.

- Amount of detergent is indicated according to following table as a guide.

*The amount of detergent is based on a type of "20-gram per 30-liter".

Since the required amount of detergent varies depending on the type of detergent, follow the instructions on the package of detergent.







INFORMATION

- If the following happens, detergent may remain undissolved and remain on your clothes.
 - If you have too much laundry
 - If the amount of detergent is too much
 - When the water temperature is low
- If you wish to use powdered detergent, we recommend that you dissolve the powdered detergent in water before using to avoid this.
- If you dissolve powdered detergent in water, you should pour it directly into the tub, as it won't fit in a regular dispenser.

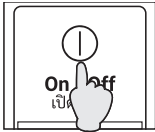
Load (guide)	Water Level	Amount of detergent	Model
8~15 kg	75~98 L	46-60 g	LTL 15MVW0T
8~13.5 kg	75~90 L		LTL H3MVW0T
8~12 kg	74~88 L		LTL 12MVW0T
8~10 kg	74~87 L		LTL 10MVW0T
4~7 kg	55~70 L	36~47 g	LTL 15MVW0T LTL H3MVW0T LTL 12MVW0T LTL 10MVW0T
0~3 kg	35~50 L	23~34 g	LTL 10MVW0T

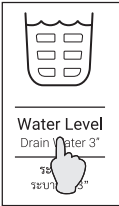
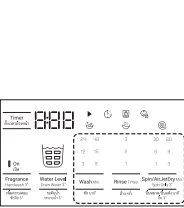
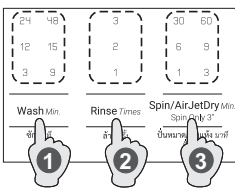
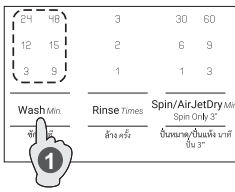
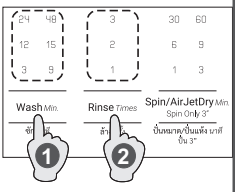
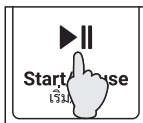
Customizing the Program

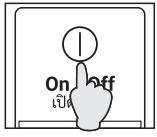
If you want...	To customize the wash program	To reuse the wash water and separate your laundry	To not spin the laundry because you are worried about wrinkles	
Operations	Wash ⇨ Rinse ⇨ Spin	Wash only	Wash ⇨ Rinse	
Setting method				
1.		Turn on the power.		
2.		Select the Normal program.		
3.		Set the amount of water. If you do not set the amount of water, it is set automatically based on the weight of the laundry.		
4.		 <ol style="list-style-type: none"> 1 Set the wash time with the Wash button. 2 Set the number of rinses with the Rinse button. 3 Set the spin time with the Spin button. 	 <ol style="list-style-type: none"> 1 Set the wash time with the Wash button. 	 <ol style="list-style-type: none"> 1 Set the wash time with the Wash button. 2 Set the number of rinses with the Rinse button.
5.		To start, press the Start/Pause button.		
Remarks	Operates according to the wash, rinse, and spin settings.	Stops while the wash water is still in the tub.	Stops while the rinse water is still in the tub.	

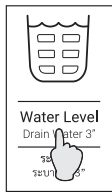
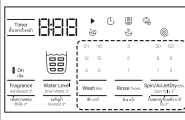
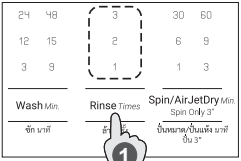
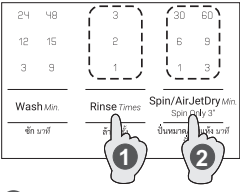
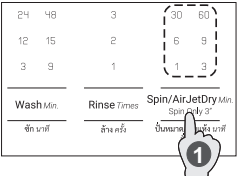
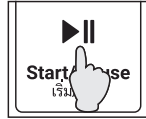
If you want...	To rinse only	To rinse and spin	To drain and spin
Operations	Rinse only	Rinse ⇄ Spin	Drain ⇄ Spin
Setting method			
1. 	Turn on the power.		
2. 	Select the Normal program.		
3. 	Set the amount of water. If the amount of water is not set, then maximum water level is used.		Cannot be used.
4.  Set the operations	 1 Set the number of rinses with the Rinse button.	 1 Set the number of rinses with the Rinse button. 2 Set the spin time with the Spin button.	 1 Set the spin time with the Spin button.
5. 	To start, press the Start/Pause button.		
Remarks	Drains water and spins before rinsing. Stops while the rinse water is still in the tub.	Drains water and spins before rinsing.	Drains water and spins.

Water Level

- Press the Water Level button until your desired setting of wash, rinse and spin are displayed. If the indicator is not lit, that operation is not performed.

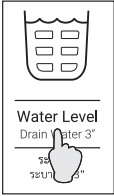

- You can set the amount of water each time you press the Water Level button.

LTL 15MVW0T : 35 to 98 L

LTL H3MVW0T : 35 to 90 L

LTL 12MVW0T : 35 to 88 L

LTL 10MVW0T : 35 to 87 L

- You can set the spin time each time you press the Spin button in a range of 1 to 60 minutes and no spinning.

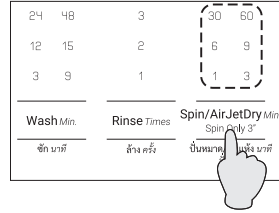

Washing Time

- You can set the wash time each time you press the Wash button in a range from 3 to 48 minutes and no washing. You can choose the time for each program.

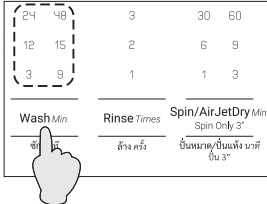

- You can set the number of rinses by pressing the Rinse button. Each time you press the Rinse button the setting changes in sequence, from Rinse 2 times, Rinse 3 times, no rinsing, Rinse 1 time.

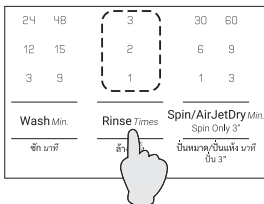

10. Care and Maintenance

Cleaning the lint filter (cassette type)

1. Press down on the knob on the top of the lint filter (cassette type) and pull it towards you.



2. Open the lint filter (cassette type) to the sides and remove the lint that is inside.

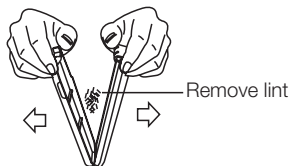

3. Reverse the procedure to replace the lint filter (cassette type).



Cleaning the dispenser

Turbo Dissolver Detergent Trap Caps

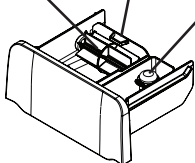

1. Pull the dispenser and tilt it upwards to remove it.

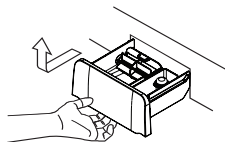

2. Pull off the caps, turbo dissolver and detergent trap.

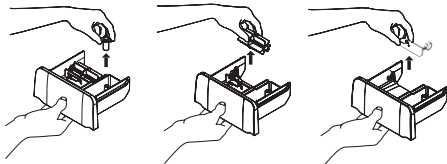

3. Clean with some tool such as brush.

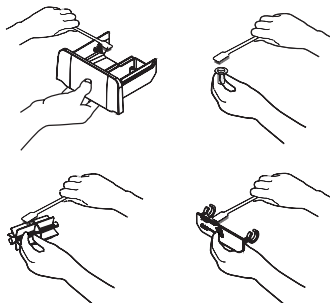

4. Put the caps, turbo dissolver and detergent trap.

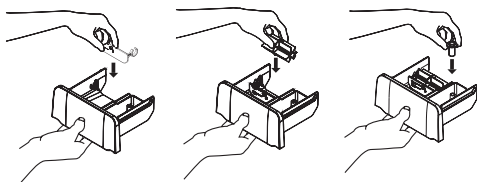

5. To remount, tilt the dispenser, align the rib to guide and insert it.

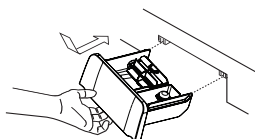

- When you replace the caps, press it until it stops completely. If it is not pressed all the way in, the softener will not be added to the tub completely and some will remain in the dispenser.

Cleaning the liquid bleach port on Top cover or Outer tub

- Use a brush or something to clean the liquid bleach port of the washing machine.

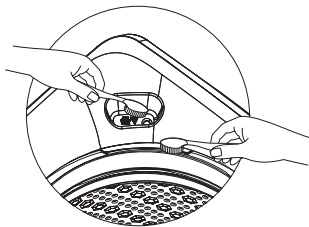

Cleaning the water supply inlet

1. Close the tap.
2. Disconnect the water supply hose from the top of the washing machine. (Water in the hose may be drained when you disconnect the hose.)
3. Use a brush or something to clean the water supply inlet of the washing machine.
4. To replace the water supply hose reverse the procedure.

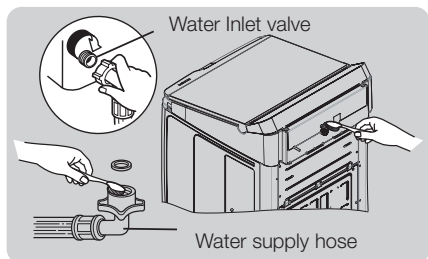

To make it even cleaner, follow these steps.

- Cleaning "Mesh filter"
1. Use pliers to pull out the mesh filter from inside the water inlet as shown.
 2. Use a soft brush to clean the mesh filter by running water through to help remove various stains and sediments.
 3. Reinsert the filter. Make sure it is tightened against water leaks.

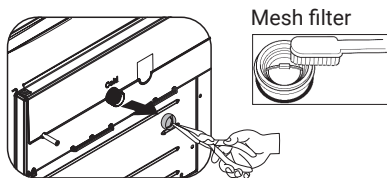

Care and maintenance of the washing machine

- Clean the machine body.
- Wipe the outside of the washing machine with a soft cloth. Do not use solvents such as alcohol or benzene.
- If you use a chemically treated cloth, use it according to the instructions given for the product.
- If detergent or softener gets on the washing machine, quickly wipe it off. The surface could be damaged.

11. Troubleshooting

Washing Machine fails to operate.

- Is the power plug not inserted in the power outlet?
 - Insert in the power outlet.
- Is there a power outage?
 - Check your other product in your home.
- Is the Timer function set?
 - Please check this function.

Washing Machine is wet, even though it is the first time to use it (drain hose, tub, etc.).

- At factory, we are checking the actual performance of each product before shipment. Some water drops might remain in the product, but this is not a malfunction. We ask for your kind understanding.

The remaining time increases during operation.

- Final spin process, There may be an imbalance of the cloth inside the tub?
 - The operation will resume the rinsing and spin process again.

Water is added again during the washing process.

- Is water added automatically up to the set water level if the water level falls because water is absorbed by the laundry?
 - To keep the preset water level, water may be added during operation.

Wash time is longer than the time that was set manually.

- Is the water pressure low?
 - The operating time may increase due to a longer water supply time, depending on the pressure level of tap water.

The lid does not open.

- Is the lid locked?
 - When the lid lock indicator is on, lid is still locked for your safety.
 - Cannot be opened because there was a power outage or the power was turned off while the lid lock indicator was lit. Turn on the power and wait for the lock to be released.
 - How to unlock the lid, please refer to page 17.

Washing Machine is a vibration and noise.









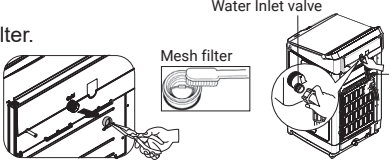

- Washing Machine is not stable or the floor itself is not leveled.
 - Please check the level, please refer to page 9.

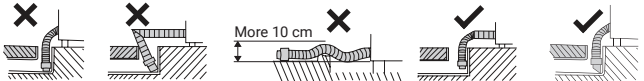
Error code does not disappear.

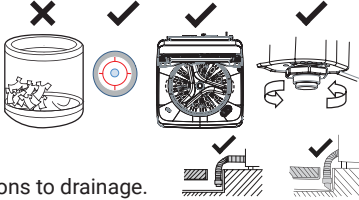
- Are you taking appropriate action?
 - Various causes are possible, please refer to page 29.
 - If that does not solve the problem, please access scan the code below.

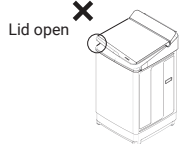

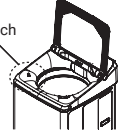
12. Error Codes

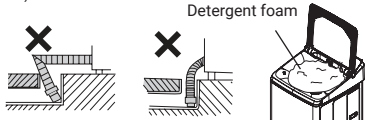
Error code	Things to check and solutions
<p>01</p>  <p>Water cannot be supplied</p>	<ul style="list-style-type: none"> - Check the water Inlet valve. - Check and clean the mesh filter. - Check water supply hose. - Open the faucet ? 
<p>02</p>  <p>Water cannot drain</p>	<ul style="list-style-type: none"> - Check the drain hose and its end. 
<p>04</p>  <p>The tub unbalanced</p>	<ul style="list-style-type: none"> - Check if the laundry is all on one side of the tub. <ul style="list-style-type: none"> • Balance the laundry evenly. - Check if the machine is on a slanted, unlevelled floor. <ul style="list-style-type: none"> • Adjust its legs, please refer to page 9. - Check that there are no obstructions to drainage. <ul style="list-style-type: none"> • "The C2 Error describes in detail how to deal with this." 
<p>08</p>  <p>The lid cannot be locked</p>	<ul style="list-style-type: none"> - Check if the lid is open. • Close it completely. - Check if the switch is pressed. 
<p>09</p>  <p>The lid lock cannot be released</p>	
<p>0h</p>  <p>The spinning speed does not reach the specified value.</p>	<ul style="list-style-type: none"> - Check if the drain hose is clogged, Install the drain hose correctly. - Check if there is too much detergent foam. • Rinse once and dehydrate by manual. 

- If warning sign such as "F0", "F9"...etc. are shown in the display, stop operating the washer immediately and contact an authorized service dealer or a service agent for inspection and repairing.

13. Specifications

Power supply	See the rating plate on the back of the washing machine.
Standard water level (maximum water level)	98 L (LTL 15MVW0T) 90 L (LTL H3MVW0T) 88 L (LTL 12MVW0T) 87 L (LTL 10MVW0T)
Standard amount of water used	285 L (LTL 15MVW0T) (Powerful program) 256.5 L (LTL H3MVW0T) (Normal program) 228 L (LTL 12MVW0T) (Normal program) 190 L (LTL 10MVW0T) (Normal program)
Water pressure	0.03 to 0.8 MPa (0.3 to 8 Kg/cm ²)
Dimensions	Width 590 mm x Depth 656 mm x Height 1088 mm
Weight	38 kg (LTL 12MVW0T / LTL H3MVW0T / LTL 15MVW0T) 37 kg (LTL 10MVW0T)

Sales and Service Center

Arcelik Hitachi Home Appliances Sales (Thailand) Ltd.

333, 333/1-8 Moo 13, Bangna-Trad Road, Km. 7, Bangkaew Subdistrict, Bang Phli District,
Samut Prakan Province 10540

Tel: 1529

Website: <https://www.hitachi-homeappliances.com/th-th/>

E-mail: service.h.ahst@arcelik-hitachi.com LINE: @hitachithailand